

# **Video Recorder User Manual**

# 1 Important Safeguards and Warnings

## **Electrical safety**

Installation and operation should conform to your local electrical safety codes. We assume no liability or responsibility for any fires or electrical shock caused by improper handling or installation.

## **Transportation security**

Heavy stress, violent vibration or water splash should be avoided during transportation, storage and installation.

## **Installation**

Keep upright. Handle with care.

Do not apply power to the NVR before completing installation.

Do not place objects on top of the NVR

## **Qualified engineers needed**

All examination and repair work should be done by qualified service engineers.

We are not liable for any problems caused by unauthorized modifications or attempted repair.

## **Environment**

The NVR should be installed in a cool, dry place away from direct sunlight and inflammable or explosive substances, etc.

This product should be transported, stored and operated in the specified environments.

## **Accessories**

Be sure to use all the accessories available in the package.

Before installation, please open the package and check all the components are included.

Contact your local retailer if something is broken or missing in your package.

## **Lithium battery**

Improper battery use may result in fire, explosion, or personal injury.

When replacing the battery, please make sure you use the same model.

## **2 Declaration**

Please prevail in kind. The manual is for reference only.

This manual may contain inaccurate data or printing error.

The products described in this manual may be updated at any time.

Screenshots of the manual is not in a machine and only for display.

If in doubt, obtaining a copy of the latest procedure or the additional document, please contact with the company's after-sales department.

## TABLE OF CONTENTS

|  |    |
|--|----|
| 1 Important Safeguards and Warnings .....      | 2  |
| 2 Declaration .....                            | 3  |
| 3 Product Introduction.....                    | 1  |
| 3.1 Product Overview.....                      | 1  |
| 3.2 Feature.....                               | 1  |
| 4 Read First .....                             | 3  |
| 4.1 Front Panel .....                          | 3  |
| 4.2 Remote Control .....                       | 4  |
| 4.3 The Mouse.....                             | 6  |
| 4.4 The Input Method.....                      | 7  |
| 4.5 Icon.....                                  | 7  |
| 4.5.1 The Screen Icons.....                    | 7  |
| 4.5.2 Operation Icons .....                    | 8  |
| 5 Installation .....                           | 8  |
| 5.1 Unpacking Inspection.....                  | 8  |
| 5.2 HDD Installation .....                     | 9  |
| 5.3 Installation of the burner .....           | 9  |
| 5.4 Alarm/PTZ/Control Keyboard Interface ..... | 10 |
| 5.5 POE Connection.....                        | 12 |
| 6 Basic Operations Guide .....                 | 12 |
| 6.1 Power On and Off .....                     | 12 |
| 6.1.1 Power On.....                            | 12 |
| 6.1.2 Power Off (Shutdown).....                | 13 |
| 6.1.3 Restart .....                            | 13 |
| 6.1.4 Power recovery .....                     | 13 |
| 6.2 Start-up Wizard .....                      | 13 |
| 6.3 Add Camera .....                           | 16 |
| 6.3.1 Channel Mode Switch .....                | 16 |
| 6.3.2 QUICK ADD IP CAMERA.....                 | 17 |
| 6.3.3 IP Channel Management.....               | 18 |
| 6.3.4 Add IP Cameras .....                     | 19 |
| 6.3.5 Modify channel configuration .....       | 20 |
| 6.3.6 Configure Front Device.....              | 20 |
| 6.3.7 Delete Front-end Device.....             | 26 |
| 6.3.8 Advanced Setting.....                    | 26 |
| 6.4 The Event of Configuration.....            | 27 |
| 6.4.1 Video Detection Configuration .....      | 27 |
| 6.4.2 Intelligent Analysis .....               | 28 |
| 6.4.3 Alarm Configuration .....                | 31 |

|       |  |    |
|-------|--|----|
| 6.4.4 | Abnormal Alarm .....                                     | 33 |
| 6.5   | Log in/Log out.....                                      | 34 |
| 6.6   | Preview.....   | 34 |
| 6.6.1 | Live Preview.....  | 34 |
| 6.6.2 | Channel Toolbar .....                                    | 36 |
| 6.6.3 | Right Click Menu .....                                   | 36 |
| 6.6.4 | Task Bar .....   | 40 |
| 6.7   | Search.....  | 43 |
| 6.7.1 | Search.....  | 43 |
| 6.7.2 | Event Search .....                                       | 46 |
| 6.7.3 | Tag Search.....  | 47 |
| 6.7.4 | Smart Search .....                                       | 47 |
| 6.7.5 | External Search.....                                     | 49 |
| 6.7.6 | Face search.....   | 50 |
| 6.8   | Record Backup .....                                      | 51 |
| 7     | Local Configuration .....                                | 52 |
| 7.1   | The Introduction of The Main Menu.....                   | 52 |
| 7.2   | INFO .....   | 53 |
| 7.2.1 | System .....   | 53 |
| 7.2.2 | Event.....   | 54 |
| 7.2.3 | Net Information.....                                     | 55 |
| 7.2.4 | LOG .....  | 57 |
| 7.3   | CONFIG.....  | 57 |
| 7.3.1 | Channel Setting .....                                    | 57 |
| 7.3.2 | Network.....   | 61 |
| 7.3.3 | Event.....   | 68 |
| 7.3.4 | Storage .....  | 68 |
| 7.3.5 | System Configuration .....                               | 72 |
| 7.3.6 | APP Center .....   | 78 |
| 8     | WEB Access .....   | 82 |
| 8.1   | WEB Operation.....                                       | 82 |
| 8.1.1 | Network Connection .....                                 | 82 |
| 8.1.2 | The control installation and the user login logout ..... | 83 |
| 8.1.3 | The Interface of Web Operations .....                    | 84 |
| 8.1.4 | Configuration.....                                       | 88 |
| 8.1.5 | Search Record.....                                       | 88 |
| 8.1.6 | Alarm Configuration .....                                | 89 |
| 9     | Appendix .....   | 91 |
| 9.1   | Alarm linkage setting .....                              | 91 |
| 9.1.1 | Alarm Out .....  | 91 |
| 9.1.2 | Linkage Record .....                                     | 91 |
| 9.1.3 | Snapshot.....  | 92 |
| 9.1.4 | PTZ Linkage.....   | 92 |
| 9.1.5 | Tour .....   | 92 |

|                                  |     |
|----------------------------------|-----|
| 9.1.6Show Message.....           | 92  |
| 9.1.7Buzzer .....                | 93  |
| 9.1.8Send Email.....             | 93  |
| 9.1.9Server Push.....            | 94  |
| 9.1.10 Send NetDisk.....         | 94  |
| 9.2Port Mapping.....             | 95  |
| 9.2.1UPNP Function .....         | 95  |
| 9.2.2Port mapping Manually.....  | 96  |
| 9.3Voice Intercom .....          | 97  |
| 9.3.1Summarize.....              | 97  |
| 9.3.2Configuration.....          | 97  |
| 9.4HDD S.M.A.R.T .....           | 97  |
| 9.5Hard disk problem.....        | 99  |
| 9.6HDD Capacity Calculation..... | 101 |
| 9.7Terms.....                    | 102 |
| 9.8FAQ.....                      | 103 |

# 3 Product Introduction

## 3.1 Product Overview

This series DVR/NVR is a high performance network video recorder, combined with H.264 video compression, high-capacity hard disk storage, TCP / IP transmission, embedded Linux operating system and a variety of other advanced technologies in the electronic information industry, all those ensure that a high-quality, low bit rate video storage characteristics, and good system stability.

This product complies with GB 20815-2006 standard video security surveillance digital video recording promulgated by the State.

Some of the products can enable the switching between the NVR mode and Hybrid mode “Hybrid mode supports both analog cameras and network cameras, NVR mode only supports network cameras”. This series product support local preview, multiple-window display, recorded file local storage, remote control and mouse shortcut menu operation, and remote management and control function. recording, playback, monitoring, synchronization of audio and video. Besides, the products support advanced control technology and strong network data transmission capacity.

## 3.2 Feature

### **Real-time monitoring**

Have a composite video signal interface and support TV, VGA or HDMI output simultaneously.

### **Compression function**

Using H.264/H.265 video compression standard and G.711 audio compression standard, can realize high definition, low code rate of the video coding to decrease the amount of data to save to HDD storage.

### **Recording function**

Support timing alarm linkage, motion detection, and other recording modes. Support SATA hard disk and local hard disk S. M.A.R.T technology. Support USB backup and network backup.

### **Video playback function**

You can search videos, within the local and network, by using the playback interface. As well as this it supports multiple videos playback, fast playing, slow playing and frame-by-frame playback. Video playback can be

displayed the exact time of the incident using a graphical timeline to allow you to search for event footage much more efficiently.

### **Camera control and alarm**

Remotely installed cameras can be controlled and various alarm devices can be connected to ensure that you know when an event has been detected, The NVR integrates Motion Detection, Video Loss, Video Block, multiple alarm output and scene lighting control into its controller options.

### **Communication Interface**

Equipped USB 2.0 high-speed interface to allow for external video backup devices. Equipped the standard Ethernet interface port (plug and play).

### **Network functions**

Support

- TCP / IP
- UDP
- RTP / RTSP
- DHCP
- PPPOE
- DDNS
- NTP
- P2P

Also support real-time network monitoring, video playback, remote control and management functions. The built-in WEB Server allows you to directly access the NVR through a web browser.

### **Operation Mode**

You can operate by the NVR's front panel or using a mouse. A simple, intuitive graphical interface is provided for intuitive operation.

### **Intelligent analysis**

Support One or Two channel Intelligent Video Analysis,, such as Face detection and perimeter analysis, Intelligent linkage pictures storage, videos, external alarm

### **Intelligent Search**

You can search video by the intelligent analysis, such as face image retrieval through face detection data, or through the perimeter video analysis data to achieve event retrieval.



## Channel Switch

The simulating device compatible with IP channel by the TVR channel switch.

# 4 Read First

## 4.1 Front Panel

| No | Name                      | Icon  | Function   |
|----|---------------------------|-------|--|
| 1  | Power                     | Power | Power button, press this button to boot up or shut down DVR/NVR.   |
| 2  | Shift                     | Shift | 1. In input Box, switch input methods;<br>2. Switch TAB;   |
| 3  | Number Key                | 1~9   | 1. Number Input(in number mode);<br>2. English character Input(in English mode);<br>3. Switch channel (in 1-ch mode).  |
| 4  | Input number more than 10 | +10   | Enter a digital larger than 10, press two-digit number:<br>1. Press the tens digit;<br>2. Press digital switch button;<br>3. Press ones digit.   |
| 5  | Up/Down                   | ↑↓    | 1.Assistant function such as PTZ menu;<br>2.In monitor mode, switch between multiple-window and one-window;<br>3. Activate the digital input box increase or decrease the number;<br>4.Active pull-down menu to switch the drop-down box options;<br>5. Activate checkbox to change status;<br>6. Activate the text input box and step down carry and abdication;<br>7. Activate the control box to move the slider;<br>8. Activate display window to select the previous channel, next channel. |
| 6  | Left/Right                | ←→    | 1. Shift current activated control, and then move left and right;<br>2. In monitor mode, switch channel.   |
| 7  | ESC                       | ESC   | Go to previous menu, or cancel current operation.  |
| 8  | Enter                     | ENTER | 1. Confirm current operation;<br>2. Go to OK button;<br>3. Go to menu.   |
| 9  | Function Key              |       | Shortcut function with FN key.   |
| 10 | Auxiliary                 | Fn    | 1. One-window monitor mode, click this button to display assistant function: PTZ control and image color;<br>2. Detection areas setting(like in motion detection setup), working with Fn and direction keys to realize setup;<br>3. In text mode, click it to delete the character before the caret(if there is no shift on the front panel, it can switch input methods), press this button for 1.5sec to clear all of the characters;<br>4. In playback mode, switch the full screen;          |

|    |                     |   |  |
|----|---------------------|---|--|
|    |                     |   | 5. Realize other special functions.  |
| 11 | Play/Pause          | ▶ | 1. Go to SEARCH interface;<br>2. In PTZ channel: ZOOM+;<br>3. In normal playback click this button to pause playback;<br>4. In pause mode, click this button to resume playback. |
| 12 | Shuttle(outer ring) |   | In real-time monitor mode it works as left/right direction key.  |
| 13 | Jog(inner dial)     |   | In real-time monitor mode it works as up/down direction key.   |

## 4.2 Remote Control

The remote control interface is shown as below:

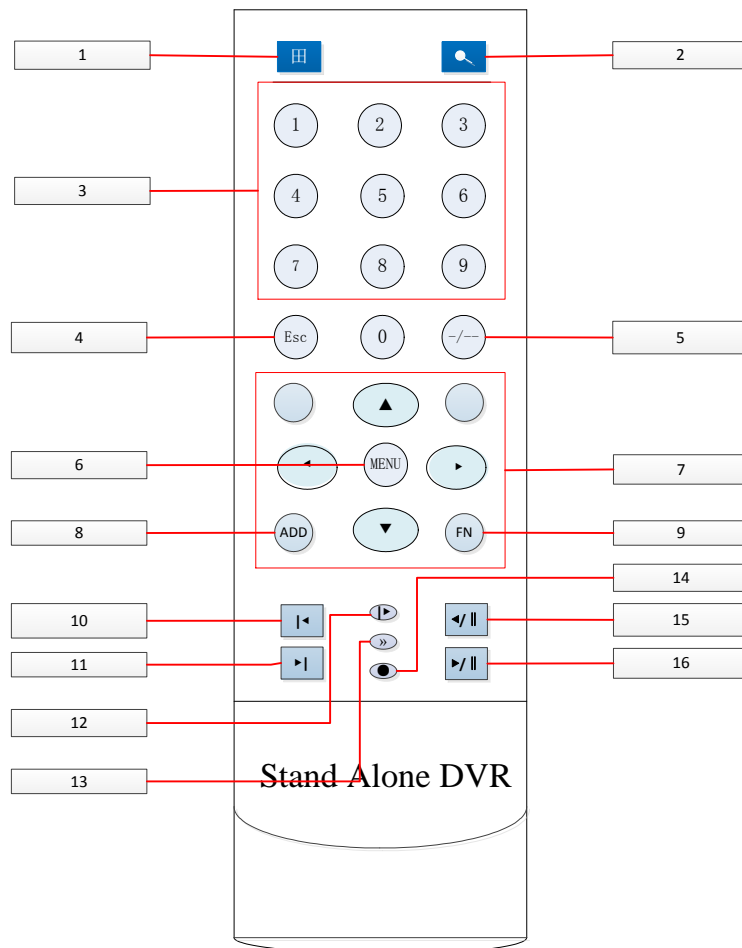

| No. | Icon | Name                   | Description                                    |
|-----|------|------------------------|--|
| 1   | 田    | Multiple-Window Switch | Switch between multiple-window and one-window. |
| 2   |      | Search                 | Access into the recording search menu.         |

|    |      |                        |  |
|----|------|------------------------|--|
| 3  | 1--9 | Number Key             | <ol style="list-style-type: none"> <li>1. Input numbers (in number mode)</li> <li>2. Input English character (in English mode)</li> <li>3. Switch channel (one-window mode)</li> <li>4. Input the password.</li> </ol>   |
| 4  | Esc  | ESC                    | <ol style="list-style-type: none"> <li>1. Go to previous menu</li> <li>2. Cancel current operation.</li> </ol>   |
| 5  | -/-- | Digital Switch         | <p>Enter a digital larger than 10, press two-digit number:</p> <ol style="list-style-type: none"> <li>1. Press the tens digit;</li> <li>2. Press digital switch button;</li> <li>3. Press ones digit.</li> </ol>   |
| 6  | MENU | Confirm/Menu Key       | <ol style="list-style-type: none"> <li>1. Confirm current operation;</li> <li>2. Go to OK button;</li> <li>3. Go to menu.</li> </ol>   |
| 7  | ▲    | Up                     | <ol style="list-style-type: none"> <li>1. Assistant function such as PTZ menu;</li> <li>2. In monitor mode, switch between multiple-window and one-window;</li> <li>3. Activate the digital input box increase or decrease the number;</li> <li>4. Active pull-down menu to switch the drop-down box options;</li> </ol>   |
|    | ▼    | Down                   | <ol style="list-style-type: none"> <li>5. Activate checkbox to change status;</li> <li>6. Activate the text input box and step down carry and abdication;</li> <li>7. Activate the control box to move the slider;</li> <li>8. Activate display window to select the previous channel, next channel.</li> </ol>  |
|    | ◀    | Left                   | <ol style="list-style-type: none"> <li>1. Shift current activated control, and then move left and right;</li> <li>2. In monitor mode, switch channel;</li> </ol>   |
|    | ▶    | Right                  | <ol style="list-style-type: none"> <li>3. Assistant function such as PTZ menu.</li> </ol>  |
| 8  | ADD  | Remote Address         | Click it to input device number, so that you can control it.   |
| 9  | FN   | Auxiliary Key          | <ol style="list-style-type: none"> <li>1. One-window monitor mode, click this button to display assistant function: PTZ control and image color;</li> <li>2. Detection areas setting(like in motion detection setup), working with Fn and direction keys to realize setup;</li> <li>3. In text mode, click it to delete the character before the caret(if there is no shift on the front panel, it can switch input methods), press this button for 1.5sec to clear all of the characters;</li> <li>4. In playback mode, switch the full screen;</li> <li>5. Realize other special functions.</li> </ol> |
| 10 | ◀    | Previous record/ Iris- | <ol style="list-style-type: none"> <li>1. In playback mode, playback the previous video;</li> <li>2. In PTZ mode, Iris-.</li> </ol>  |
| 11 | ▶    | Next record/Iris+      | <ol style="list-style-type: none"> <li>1. In playback mode, playback the next video;</li> <li>2. In PTZ mode, Iris+.</li> </ol>  |
| 12 | ▶    | Next Frame             | Playback the next frame (frame by frame)   |
| 13 | »    | Fast Playback          | Various forward speeds and normal speed playback.  |
| 14 | ●    | Stop                   | In normal playback click this button to stop playback.   |
| 15 | ◀/   | Reverse/Pause          | 1. In normal playback click this button to pause playback;   |

|    |     |            |   |
|----|-----|------------|---|
|    |     |            | 2. In pause mode, click this button to reverse playback.  |
| 16 | ▶/⏸ | Play/Pause | 1. In normal playback click this button to pause playback;<br>2. In pause mode, click this button to resume playback. |

The procedures of controlling multiple DVR by remote control:

The DVR ID default is 8. It's no need to reset it when control one single DVR by the remote control. If you need to control multiple DVR, do as below:

First activate the remote control: choose controlled DVR, starts successfully, aim the remote control to control the hard disk video recorder, press the "Add" button, input device ID) between (1-999), then press ENTER to determine can control the corresponding number of hard disk video recorder.

## 4.3 The Mouse

In addition to front panel keys and remote control menu, the user can use a to control. Insert the mouse interface into the USB interface.

### Left Click

Left click to enter the right menu or the main interface.

Left click to access the menu option.

Perform the operations instructions of the control.

Change the state of the checkbox or dynamic detection blocks.

Pop up a drop-down list when left click.

In the state of PTZ 3D control, left drag the area to achieve regional enlarging or reducing. See details zoom effect

4.1.2 PTZ control section introduction.

### Double Click

Double click to play video.

Double click to make the screen full or exit.

### Right Click

Right click to pop up the right menu in the real-time monitoring screen.

Exit the current interface without saving.

### Turning Wheel

Turn the mouse wheel to change the value in the digital box.

Switch the option of the combination box.

Scroll back and forth to achieve the zoom function of channels and PTZ 3D.

### Mouse Move

Select controls of the current coordinates to move.

### Mouse Drag

Select area to detect.

Select area to shelter.

Select zooming function of PTZ control.

## 4.4 The Input Method

capitalization and the input of Chinese. Click the mouse to complete the input.”← “represents the backspace and “\_” represents a space.

**In the input box, you can select figures, symbols, English** The input interface of English:



**figures:**

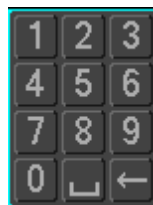

**The input interface of Chinese:**

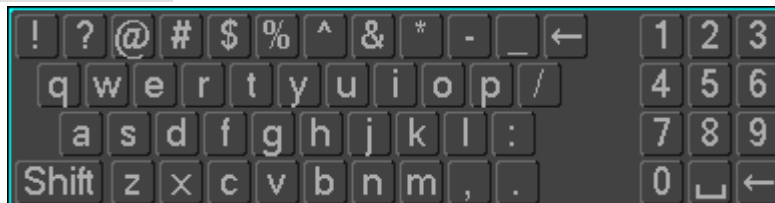

## 4.5 Icon

### 4.5.1 The Screen Icons

● : The channel is recording.

 : The video of the channel is lost.

 : Motion detection occurs.

 : The channel is in monitoring and locked status.

 : Adjust the size of the logo of the local audio output.

 : Allow screens to round of the Tour.

## 4.5.2 Operation Icons

 : Not selected.

 : Be selected.

 : The drop - down button

 : Leave the interface.

 : Cancel the settings.

 : Set parameters.

 : Save parameters.

 : Restore the factory settings.

 : Apply current settings to the system.

 : Copy current settings to other channels.

 : Enter the configuration interface.

 : Select and configure the processing operation triggered by video detection or alarm.

# 5 Installation

## 5.1 Unpacking Inspection

When you receive the product, check according to the packing list in the box.

## 5.2 HDD Installation

### Installation Preparation

Prepare a Cross Screwdriver.



*Note: HDD quantity by each model's specifications shall be final, HDD capacity up to 64 TB.*

### Steps

Remove the metal top cover by removing two screws from the sides of the cover.

Place the hard disks on a flat table and tighten the screws.

Connect the power and the data lines to the HDD.

Reinstall the metal top cover and tighten the screws.

### Caution

Only use the HDD specified by the manufacturer.

The HDD will be formatted automatically during booting and it may cause data loss.

The total duration of video data saved is decided by the HDD's capability and the DVR's parameters (recording setup, encoding setup). Please refer to the form in chapter 11.5.

## 5.3 Installation of the burner

### Installation Preparation

Prepare a Cross Screwdriver.

### Steps

Unscrew the screw on the side of the chassis and open the case cover.

Use a screwdriver to remove the bracket fixed in middle of the disk.

Open the front panel door and remove the baffle inside.

Connect the burner data cable and the power cord.

Fix the chassis cover.

### Caution

The installation of the built-in burner is only for specific DVR and affects disk space for installation and interfaces.





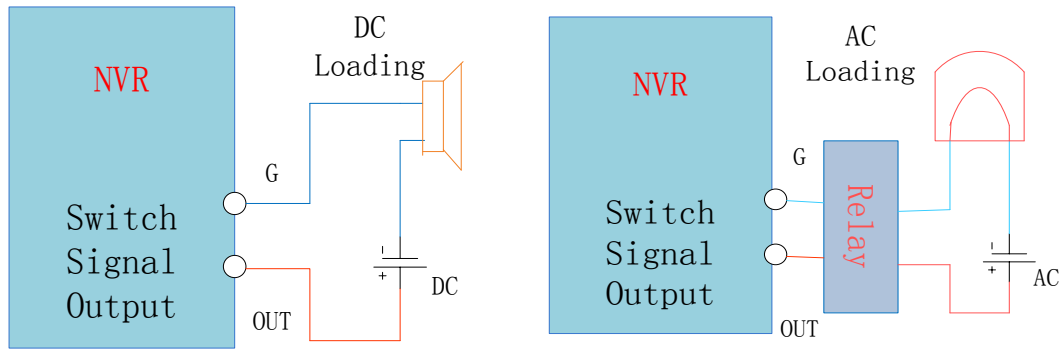

See details 7.2.5.

### **The Connection of the P/T/Z**

The A, B interface of the PTZ decoder connect with A and B interfaces of the DVR's RS-485. 120Ω resistors should be paralleled in the remote A, B lines to reduce the distortion of the signal if a larger number of PTZs are connected.

See details 7.2.4.

### **Keyboard**

The A, B interface of the Keyboard connect with A and B interfaces of the DVR's RS-485, [MAIN MENU]-[CONFIGURATION]-[P/T/Z], Protocol choose KEYBORAD. See below.

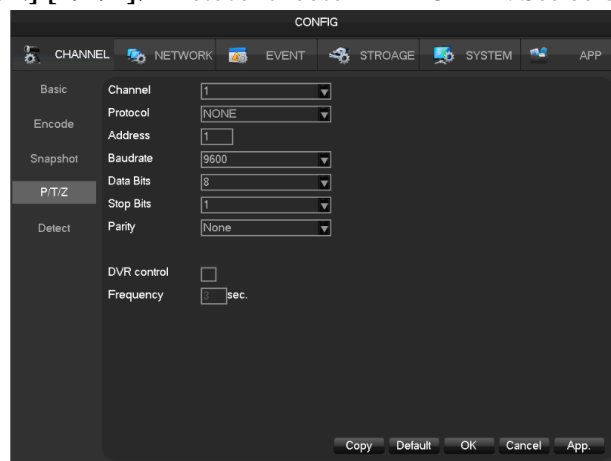

## 5.5 POE Connection

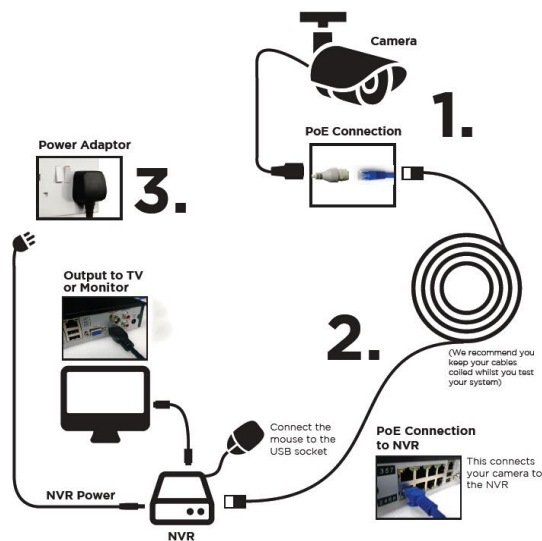

- Non-safe voltage 48V, please pay attention to electrical safety. Supply the NVR with the 12V DC power.
- IP Camera should support the POE.
- The theoretical distance of POE power supply should below 100 meters.

# 6 Basic Operations Guide

## 6.1 Power On and Off

### 6.1.1 Power On

Install the DVR/NVR correctly (as above) and then connect the power. The DVR/NVR LED should light up and the DVR/NVR will boot automatically.

The DVR/NVR will then automatically detect any connected hardware (cameras, monitors, etc.), this process should last about 30 Seconds. When this process has been completed the DVR/NVR will enter the multi-screen real-time surveillance mode.

If your hard drive is not properly connected, the following message will appear on your screen.

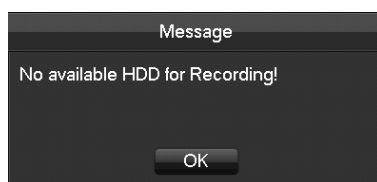



*Note: Please do not use any type of power supply which is different from the power supply included in this kit.*

## 6.1.2 Power Off (Shutdown)

Right mouse click -[Main Menu]-[Shutdown]

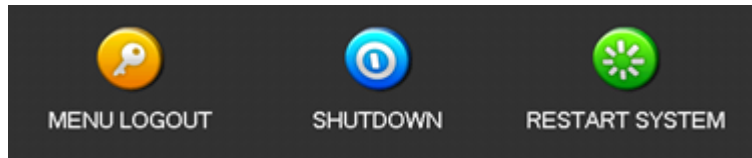

*Note: Only change or attempt to reconnect the hard disk drive after shutting down the DVR/NVR.*

## 6.1.3 Restart

Right mouse click -[Main Menu]-[Shutdown]-[Restart system]

## 6.1.4 Power recovery

Reboot after an outage or forceful shutdown, DVR will save the record before outage and return to the normal operation mode.

## 6.2 Start-up Wizard

Quick configuration includes P2P account & password setting, network configuration, intelligent mode selection.

### Help Information

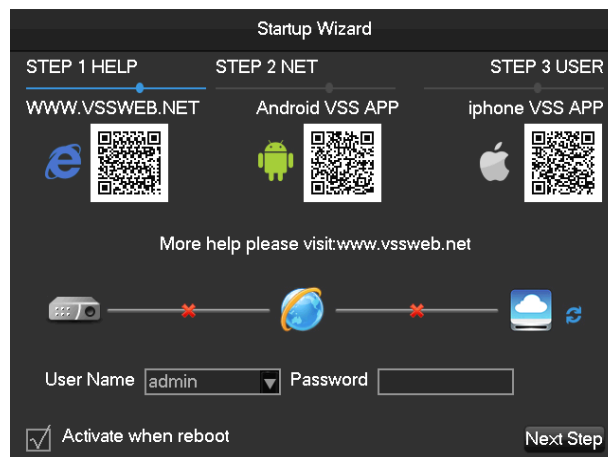

[QR code] From left to right: Web access address, Android APP address, iPhone APP address.

**[Network Connection Status]** The current network status.

**[Log In Account]** The login account and password, with the correct account and password can enter the menu.

Default account is admin, and password is 123456.

**[Start-up wizard]** Activate or not when reboot.

## Network configuration

Startup Wizard

STEP 1 HELP    STEP 2 NET    STEP 3 USER

DHCP

IP Address 10 . 12 . 4 . 39

Subnet Mask 255 . 255 . 255 . 0

Gateway 10 . 12 . 4 . 1

AUTO DNS

DNS1 8 . 8 . 8 . 8

DNS2 192 . 168 . 1 . 1

P2P Account Info

P2P ID 0020a5e2 Password DAm4bY

Activate when reboot

Save Previous Next Step

**[DHCP]** Tick DHCP Enable. Once enable the DHCP, IP address, gateway and subnet mask will get automatically, can't be set.

**[IP address]** Enter the number or press up & down button (▲▼) to change the IP address and **[Subnet Mask]** and **[Gateway]**.

**[AUTO DNS]** Enable the **[AUTO DNS]**, DVR will get the DNS from the DNS server, no need to set.

**[DNS 1]** DNS server IP.

**[DNS 2]** DNS alternate IP.

**[P2P Account Info]** Scan it and shows P2P account, login with mobile APP.

**[P2P Account]** Display the current P2P account and password.

## Account



**[Add Users]** Add a new user.

**[Modify User]** Modify the user name, groups, authorities.

**[Add Group]** To add a user group, and configure the user group right.

**[Modify Group]** Modify the permissions belong to Group

**[Modify Password]** Modify the Login password

### Intelligent mode selection

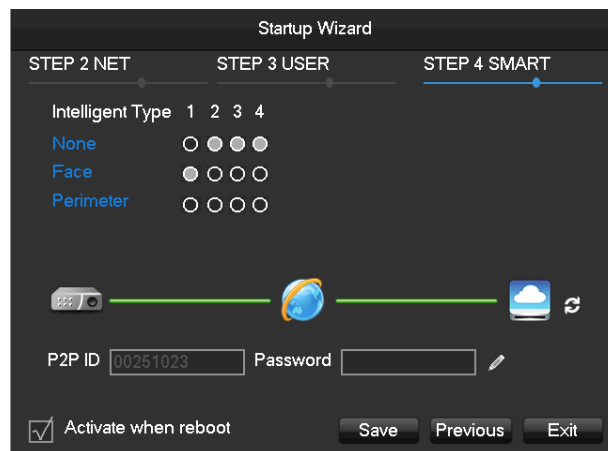

**[Intelligent mode selection]** Intelligent mode selection.



*Feature is only available on certain devices. In this section showing the device's menu system may differ to menu system on the device you are using.*

## 6.3 Add Camera

### 6.3.1 Mode Switch

To TVR, compatible local channels with net channels by the channel mode switch.

[Main Menu]- [Channel]-[Mode Switch] to switch the channel mode.

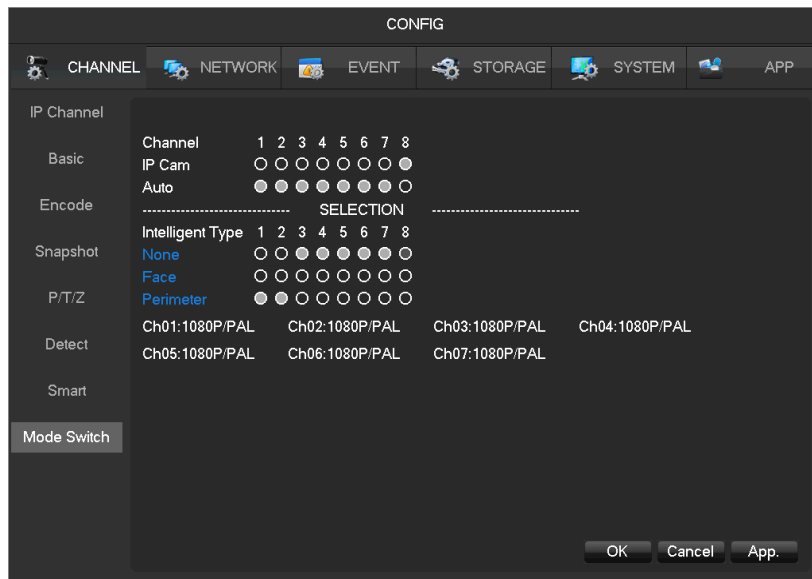

[IP Cam] IP mode, can connect IP camera into the current channel.

[Auto] Local channel mode, identify the video standard and resolution automatically.

The default will display the biggest input capacity, the format is “channel No.: resolution/video standard” and will real-time display the current resolution.

The preview screen will display the resolution and video standard once the camera is connected, the format is “resolution/video standard”, and the display time is 3sec.

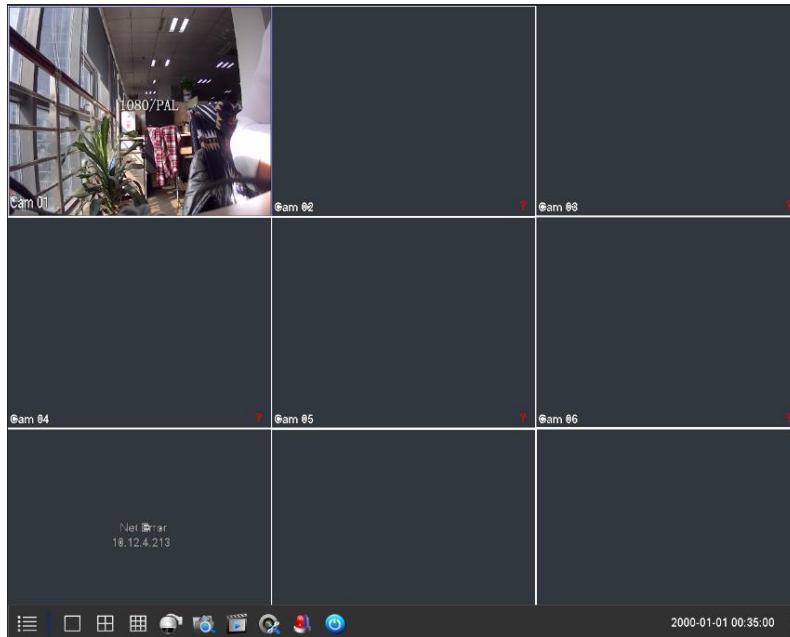

Due to the hardware differences, device will prompt wrong information once the connected signal is not supported.



There are differences to the automatic identify feature supporting to the different models. In this section showing the device's menu system may differ to menu system on the device you are using.

## 6.3.2 QUICK ADD IP CAMERA

In preview screen, move the mouse to the network channel, it will show "+" sign, left-click to enter the following menu:

CONFIG

CHANNEL NETWORK EVENT STORAGE SYSTEM APP

| IP Channel  | ID | Add/Del | Status | IP/DoMain    | Port  | WebPort | Protocol | Edit | Advanced |
|-------------|----|---------|--------|--------------|-------|---------|----------|------|----------|
|             | 08 | ×       | ●      | 10.12.4.17   | 8000  | 80      | TYPE1    | ⚙    | ⚙        |
| Basic       | 01 | +       | --     | 10.12.4.19   | 8000  | 80      | TYPE1    | ⚙    | ⚙        |
|             | 02 | +       | --     | 10.12.4.36   | 8000  | 80      | TYPE1    | ⚙    | ⚙        |
|             | 03 | +       | --     | 10.12.4.39   | 8000  | 80      | TYPE1    | ⚙    | ⚙        |
| Encode      | 04 | +       | --     | 10.12.4.64   | 8000  | 80      | TYPE1    | ⚙    | ⚙        |
|             | 05 | +       | --     | 10.12.4.89   | 8000  | 80      | TYPE1    | ⚙    | ⚙        |
| Snapshot    | 06 | +       | --     | 10.12.4.123  | 8000  | 80      | TYPE1    | ⚙    | ⚙        |
|             | 07 | +       | --     | 10.12.4.124  | 8000  | 80      | TYPE1    | ⚙    | ⚙        |
| P/T/Z       | 08 | +       | --     | 10.12.4.136  | 9000  | 8080    | TYPE1    | ⚙    | ⚙        |
|             | 09 | +       | --     | 10.12.4.137  | 8000  | 80      | TYPE1    | ⚙    | ⚙        |
|             | 10 | +       | --     | 10.12.4.150  | 8000  | 80      | TYPE1    | ⚙    | ⚙        |
| Detect      | 11 | +       | --     | 10.12.4.160  | 8000  | 80      | TYPE1    | ⚙    | ⚙        |
|             | 12 | +       | --     | 10.12.4.163  | 8000  | 80      | TYPE1    | ⚙    | ⚙        |
| Smart       | 13 | +       | --     | 10.12.4.178  | 8000  | 80      | TYPE1    | ⚙    | ⚙        |
|             | 14 | +       | --     | 10.12.4.218  | 8000  | 80      | TYPE1    | ⚙    | ⚙        |
| Mode Switch | 15 | +       | --     | 10.12.4.219  | 8000  | 80      | TYPE1    | ⚙    | ⚙        |
|             | 16 | +       | --     | 10.12.4.220  | 8000  | 80      | TYPE1    | ⚙    | ⚙        |
|             | 17 | +       | --     | 10.12.4.237  | 8000  | 80      | TYPE1    | ⚙    | ⚙        |
|             | 18 | +       | --     | 192.168.1.80 | 8000  | 80      | TYPE1    | ⚙    | ⚙        |
|             | 19 | +       | --     | 192.168.1.88 | 8000  | 80      | TYPE1    | ⚙    | ⚙        |
|             | 20 | +       | --     | 10.12.4.222  | 27777 | 80      | TYPE2    | ⚙    | ⚙        |

Filter Search Add Delete Ping Status Open UPnP

**Search add**

Click [Filter] to select the protocol;

Click [Search] to search devices;

Click “+” to add device.

### Manual add

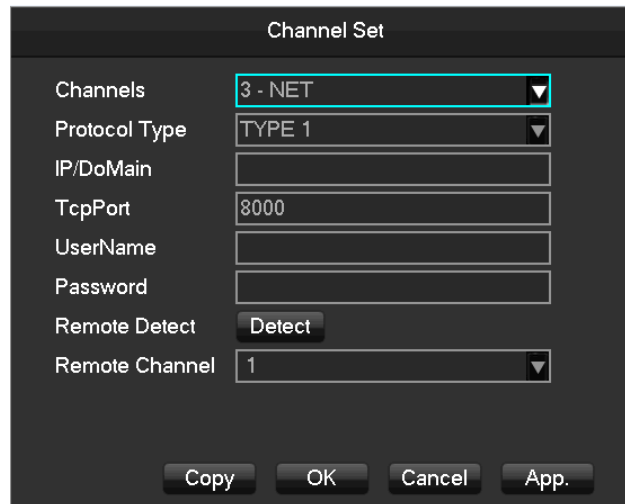

**[Channels]** Choose one channel.

**[Protocol]** Choose protocol supported by the device.

**[IP/ Domain Name]** Input front device IP address or domain name.

**[Port]** Input front device TCP port.

**[Username]** Input front device username.

**[Password]** Input front device password.

**[Remote Detect]** After completing the above settings, click detect button to check connection status.

**[Ping]** Check whether the current network is to be connected.

**[Remote Channel]** When the front device includes multiple channels, choose one channel for it.

Click “App” button to finish.

## 6.3.3 IP Channel Management

If the device support IP channel can use IP channel management page for add or delete IP devices and set the front-end configuration.

There are three ways to log in **[IP Channel]**

1、Living preview, click the button  in the menu bar.



2、 Right click the mouse on the living preview, click the button **IP Channel** in the right-click menu.

3、 **[Main Menu]-[Channel]-[ IP Channel]**

IP channel management menu as the following page:

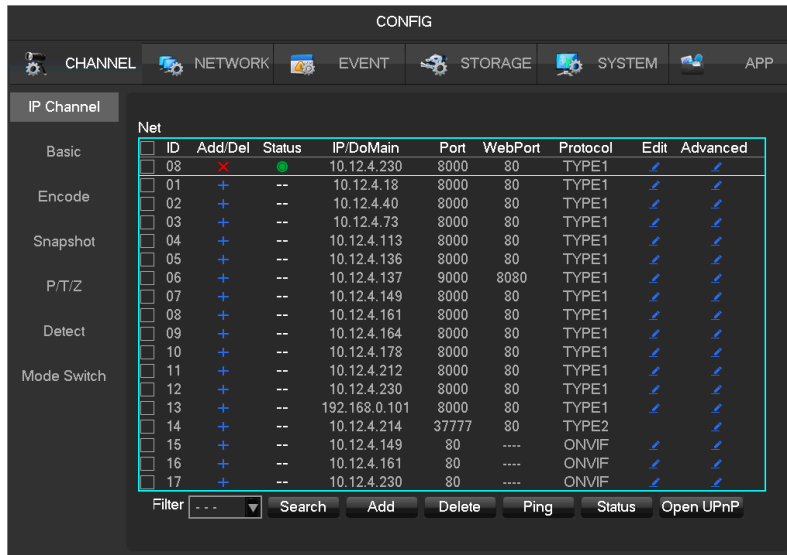

**[Check Box]** Click the check channel, double click can deselect channel, Click the title bar to achieve selection, double click can deselect all.

**[Serial Number]** Display the network channel number to add equipment serial number.

**[Add、 Delete]** Click **X** Delete the current network equipment. Click **+** add the network equipment.

**[Status]** Show the current channel connection status: **●** Connection is normal, **✎** ID or Password is wrong, **●** the equipment is offline, **🔒** User is lock.

**[IP Address/Domain Name]** Display the equipment's IP address/domain name.

**[Port]** Display the port number

**[Web Port]** Display the web port number.

**[Agreement]** Display the connection agreement.

**[Edit]** Configure the channel information, show in 6.3.6.

**[The Front-end Configuration]** Configure the camera's parameters.

## 6.3.4 Add IP Cameras

There are three ways to add IPCs.

### Automatically Add

No configuration, the device is automatically added.

Click [**Open UPNP**] in [**IP Channel Management**] menu page.



*Note: The device should support UPNP and should be in the same LAN.*

### **Searching Add**

Search all the IPCs in the network environment and then choose one or mass to add. To do the following steps in [**IP Channel Management**] menu page:

Click [**Filter**] to select the protocol;

Click [**Search**] to search devices;

Click + to add device or Right click [**Add to**] to choose the channel you want or tick the devices you want to add, then click [**Group Add**].



*Need to update the password by manually after connecting the camera.*

### **Manual Add**

The details see 6.3.2, manual add.

## **6.3.5 Modify channel configuration**

Click “Edit” button in the IP Channel list.

Modify the information table, the table details see 6.3.2

## **6.3.6 Configure Front Device**

Basic configuration, encoding configuration, snapshot, network and motion detection of front device can be set in NVR.

Click “Front Setting” button of device in [**IP Channel Management**] menu.

### **BASIC**



**[Channel Choose]** Choose a channel.

**[Channel Name]** Modify current channel name.

**[IPC Current Time]** Set IPC time.

**[Time Zone]** Set time zone.

**[Time Sync]** Enable IPC time sync with NVR.

**[Control IPC]** Click the prompt whether restart the IPC, **[OK]**Restart the IPC, **[Cancel]**Return.

## Encoding

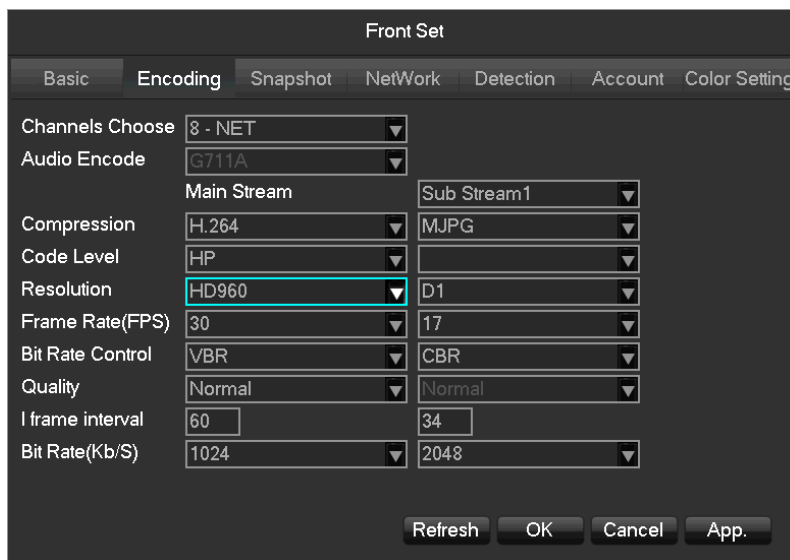

**[Channels Choose]** Choose one channel.

**[Audio coding]** Select the current audio encoding

**[Code Level]** H.264

**[Resolution]** Choose main resolution and sub resolution.

**[Frame Rate]** 1~25FPS/PAL,1~30FPS/NTSC

**[Bit Rate Control]** Choose CBR or VBR. When choose CBR, bit rate can be set. When choose VBR, image quality can be set.

**[Picture Quality]** Choose the picture quality by the Variable stream, there are 6 range to choose.

**[I frame interval]** Set interval of adjacent frames. Max is 150.

**[Bit Rate]** Choose 1280,1536,1792,2048,3072,4096,5120,6144,7168,8192 or set by yourself.



*The range of resolution and frame rate subject to the actual device.*

## Snapshot

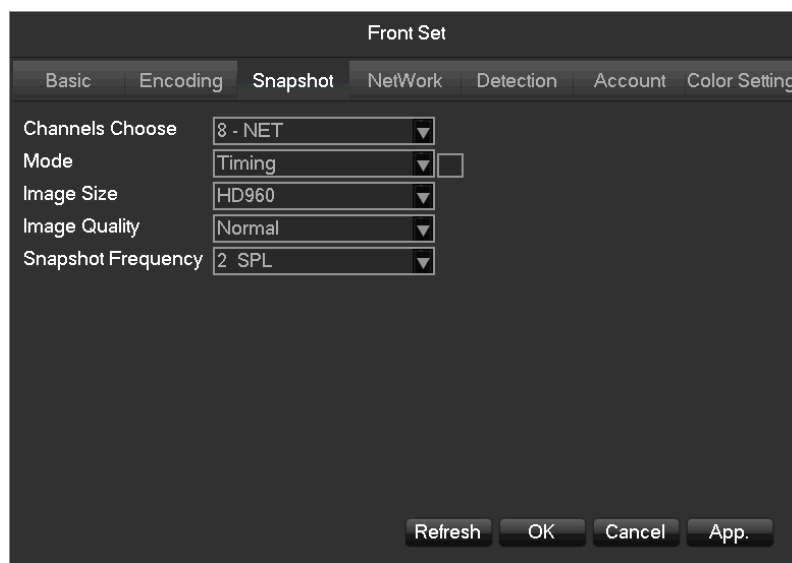

**[Choose Channel]** Choose the channel to be modified.

**[Snapshot Mode]** Support two modes: trigger snapshot and timing snapshot, the timing snapshot must tick the checkbox.

**[Picture Resolution]** Set the captured picture resolution.

**[Picture Quality]** Choose the picture quality, there are 6 range to choose.

**[The Frequency Of Highest Snapshot]** Support 1sec./pcs.~8sec./pcs 8 ranges of snapshot to choose.

## Network



**[Channels Choose]** Choose one channel.

**[DHCP]** Automatic get the IP address.

**[IP Version]** Choose the internet protocol version, IPV4 /IPV6.

**[IP Address][Subnet Mask][Gateway]** Set IP address, subnet mark and gateway for the device.

**[First DNS Server]** Set DNS server IP address.

**[Alternate DNS Server]** Set standby DNS server IP address.

**[MAC/Serial]** Show MAC address of front device.

## Detection

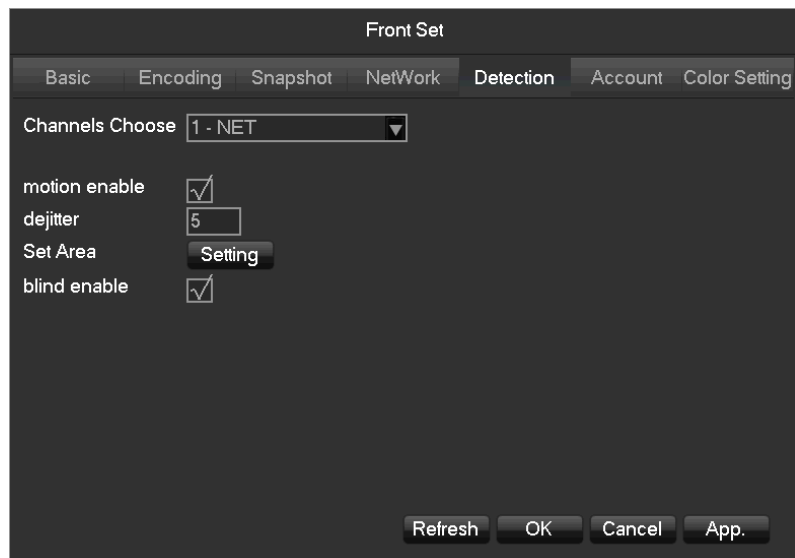

**[Channels Choose]** Choose one channel.

**[Motion Enable]** Enable the motion detection alarm or not.

**[Dejitter]** Only record one alarm event in this time, the default is 5sec.

**[Set Area]** Set the motion detection area. There are 396 (22\*18) regions can be set.

There are 6 sensitivity levels for motion detection.

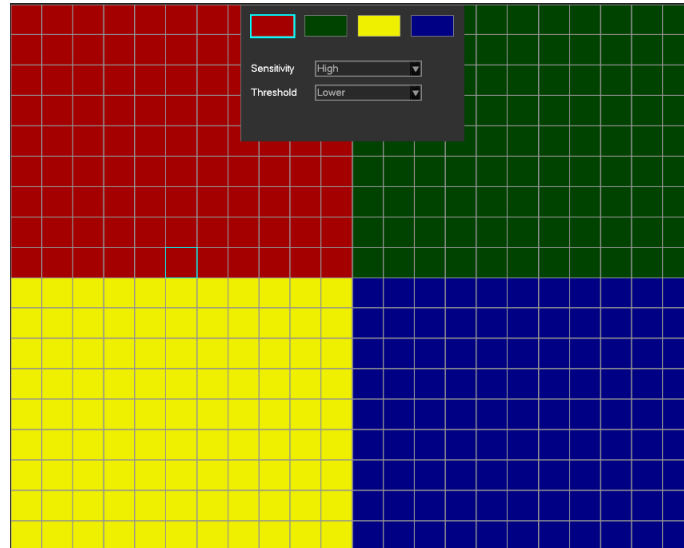

The network protocol selected when connecting the IPC must supporting to configurate this feature. All the settings are for front device.

**[Blind Enable]** Enable the blind detection alarm or not.

### Account

To get the IPC's account list.

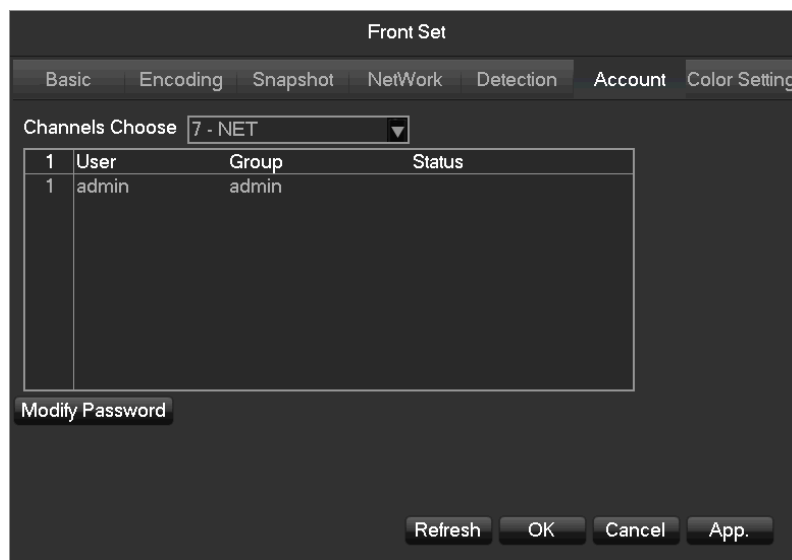

If the current account is administrator will get the whole account list, or can't get the other accounts information.

## Color Setting



**[Channels Choose]** Select channel to modify.

**[Config File Manage]** Support three modes, always, common, time.

**[Always Use]** Support two modes, day configuration and night configuration.

**[Image Params]** Get and modify the front device's image params.

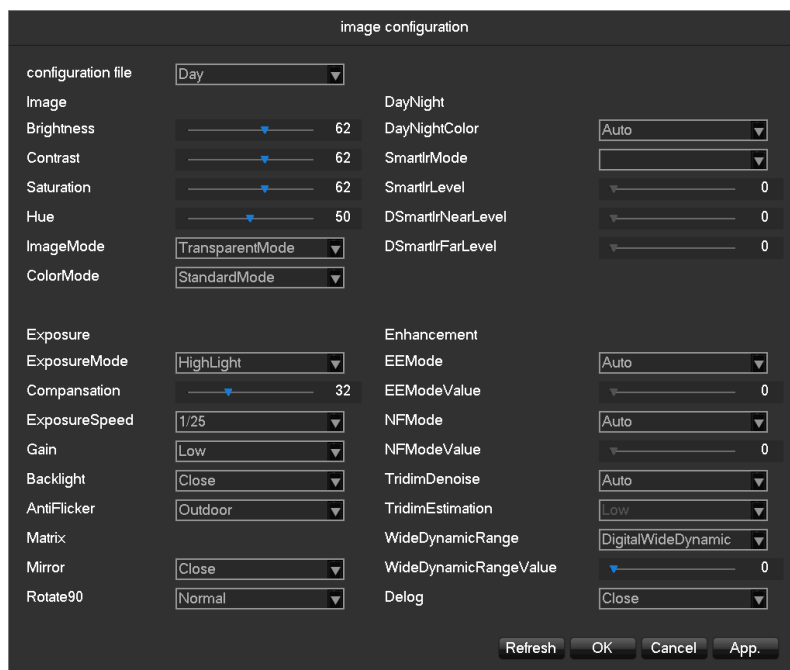

*Subject to the front-end device model, the menu may differ the current menu in you own.*

### 6.3.7 Delete Front-end Device

Click button  to delete the device in [IP Channel Management] menu.

Checkmark several devices and click “Batch Delete” to batch delete devices.

### 6.3.8 Advanced Setting

Click the advanced setting button, will show the Advanced Setting menu.

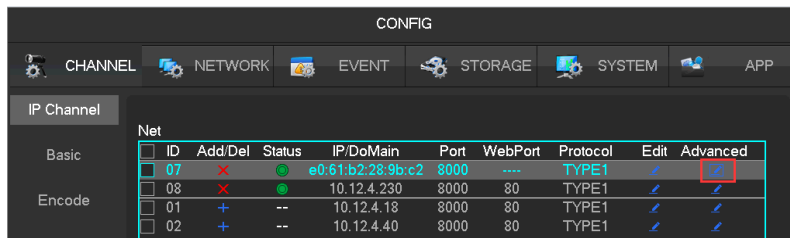

The front-end device has been added into IP channel:



[Front Set] Reference 6.3.6

[Automatic Detection] Check connection status of the current channel.

[ShortCut PING] Check the current channel network whether is connected.

[Alarm Output] Set the front-end device alarm output mode.

[Channel exchange] Exchange position of channels.

The front-end device has not been added into IP channel:



[ShortCut PING] Check the current equipment whether is connected.

[Add To] Add device into the special channel.



## 6.4 The Event of Configuration

The events are those user not expected, including traditional alarm events, equipment abnormal events, intelligent analysis.

Configure an event obey four parts: the event type, rules, protection plan, alarm linkage.

### 6.4.1 Video Detection Configuration

The video detection includes motion detection, video lost, video blind.

[Main Menu]-[Channel]-[Detect] Enter into the configuration interface.

#### Video detect

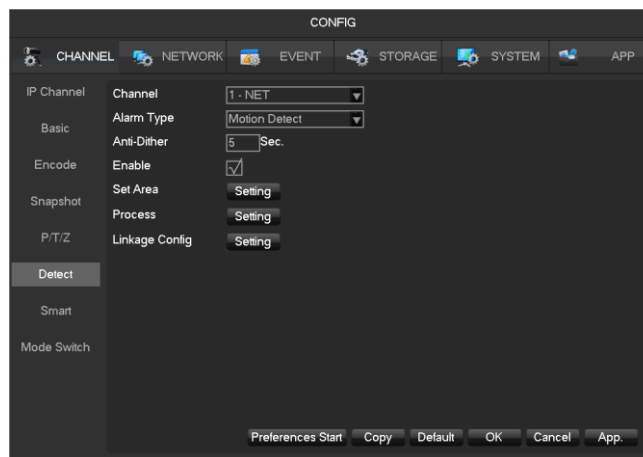

[Channel] Select a channel.

[Alarm Type] Motion detection, video lost, video blind and VQD.

[Motion Detection] Detect the motion in the picture, and send alarm according to setting.

[Video Lost] Detect the video loss and send alarm according to setting.

[Video Blind] Detect the video which was covered and send alarm according to setting.

[VQD] Analysis the video quality, if virtual, camera move or color cast, then will alarm based on the alarm plan.

[Anti-Dither] Will only alarm one time during this time, the default is 5sec.

[Enable] Enable the alarm or not.

[Set Area] There are totally  $22 \times 18 = 396$  area can be set, support 4 kinds of sensitivity.

**Sensitivity:** Highest, higher, middle, low, lower, lowest.

[Process] Set the alarming time, linkage and the handling method.

**[Linkage Config]** Set the alarm linkage and the handling method.

**[Preview]** It will show a test on the current setting.

**[Copy]** Copy the setting to other channels.

## 6.4.2 Intelligent Analysis

Cooperate with our IPC, IPC's firmware version 112, can achieve the intelligent communication function.

A part of devices support face detection and parameter detection function. The recorder analysis not rely on the camera.

### Mode Switch

If the device supports intelligent analysis, enter into menu **[main menu]-[Channel]-[Mode Switch]**. Choose the channel to open the intelligent analysis function or change the intelligent function of the equipment.

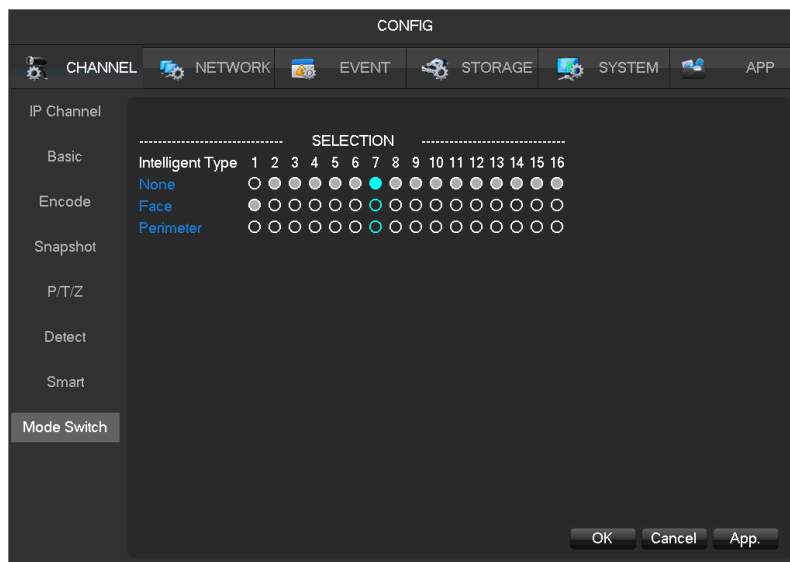

*The local Intelligent analysis feature depends on the mode.*

### Smart Configuration

Cooperation with our IPC, IPC's firmware version 112, can achieve the intelligent communication function.



**[Channel]** Select Intelligence channel.

**[Alarm Type] Built-in face detection and perimeter.**

**[Face Detection]** Capture faces and alarm.

**[Perimeter]** Analyzing move target forward, backward across the line and invading the region and left and generates an alarm.

**[Enable]** Open intelligent analysis.

**[Track Enable]** Tracking control box on and off

**[Settings]** Set the intelligent analysis rules. The details see appendix 6.4.2.

**[Process]** Choose the protection plan, enter the editing plan that we can configure the time of protection every day.

**[Linkage Config]** Show in the appendix 9.1 about set alarm linkage.

## Face Detection Configuration

When a device open the face detection function, enter the page of face detection by **[Channel]-[Smart]:**

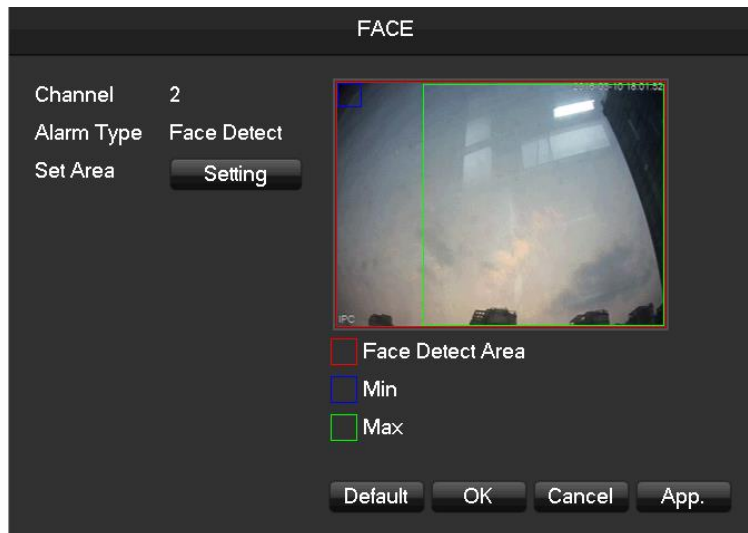

**[Channel]** Select Intelligence channel

**[The minimum]** The minimum area of the face detection, blue scope refer to the minimum area of the face, the face can't be picked if the face less than the minimum area of the face detection. According to the practical use of scene and the expected area of the face detection to set the function.

**[The biggest]** The biggest area of the face detection, green scope refer to the biggest area of the face detection, the face can't be picked if the face bigger than the biggest area of the face detection. According to the practical use of scene and the expected area of the face detection to set the function.

**[red scope]** Detection area, after set the function, the equipment only can detect the area of the face, Can effectively reduce false positives and omission.

### **Perimeter Intrusion detection configuration**

When the equipment open the perimeter analysis function, can enter the perimeter setting page by

**[Channel]-Alarm Type-Perimeter.**



*Note: if there is no channel to analysis the perimeter detection, you can set the function by **[Channel]-Alarm Type-Perimeter***

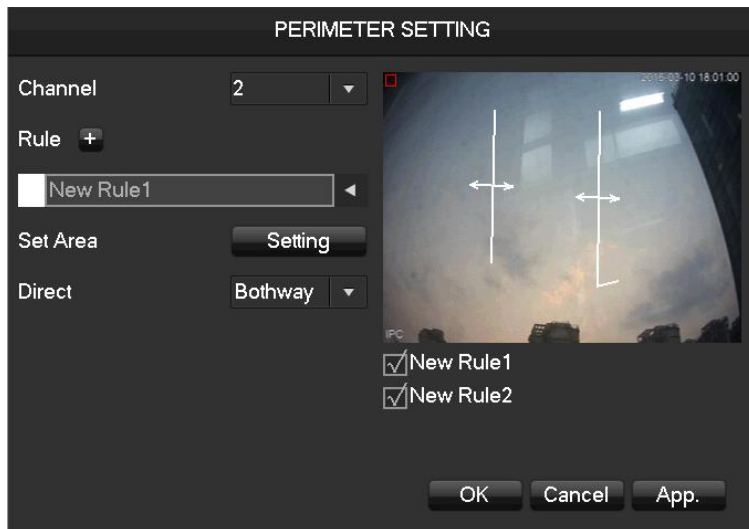

**[Channel]** Choose the channel of the perimeter analysis.

**[Rule]** Click “+” add rule.

**[Set Area]** Set current rule line what you choose.

**[Direct]** Set the fold line rules to sure the detection direction.

**[Rule]**

Click [+] make the new perimeter analysis rule.

Click the color box to set the line of color rule, show in the picture:

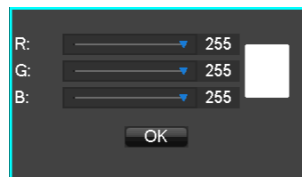

Click the rule name can modify the name.

Click the drop -down menu to choose the other rule, then can delete the rule.

## 6.4.3 Alarm Configuration

### Alarm Input

**[Main Menu]-[Event]**

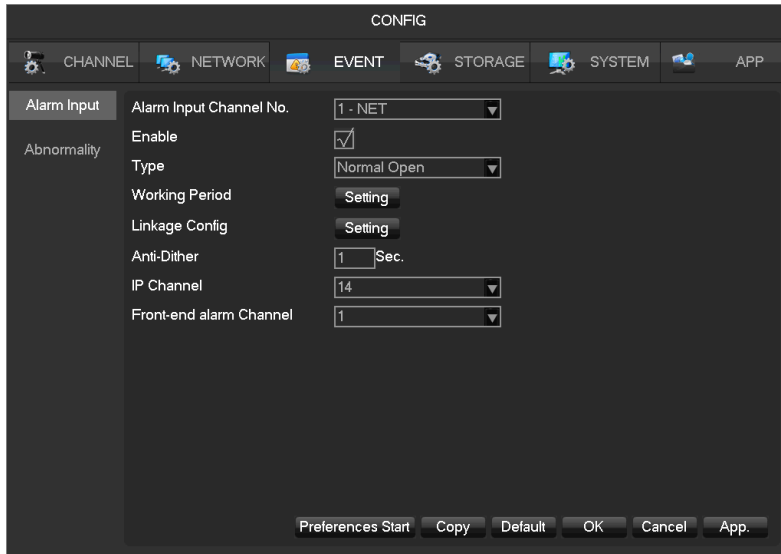

**[Alarm Input Channel No]** Select a channel.

**[Enable]** Control the open and close of alarm.

**[Type]** Choose Normal open and Normal close.

**[Process]** Set the alarming time, linkage and the handling method.

**[Set Linkage]** Show in the appendix 9.1 about set alarm linkage.

**[Preview]**It will show a test on the current setting.

**[Copy]** Copy the setting to other channels.

## Alarm Output

On the real time preview picture, right click and choose **[Alarm Output]**, or enter

**[Main menu]-[Event]-[Alarm Output]**

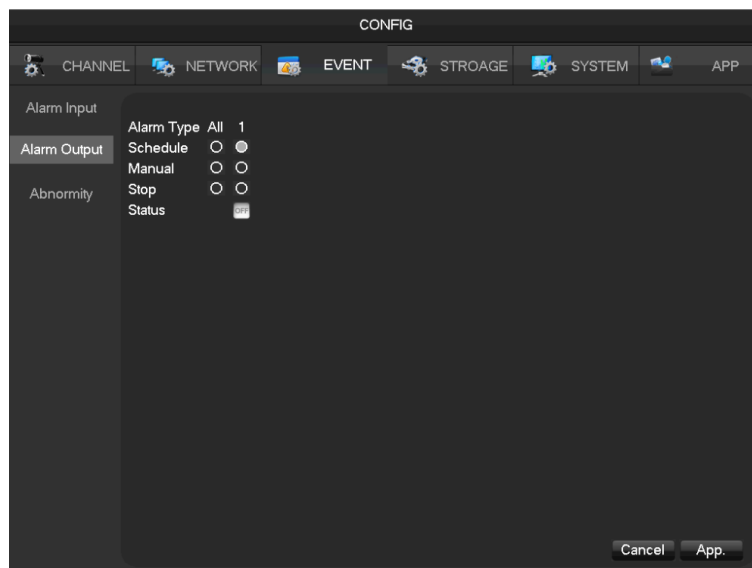

**[Schedule]** Alarm output is controlled by the device's linkage setting.

[**Manual**] Alarm output is on and the status is active.

[**Stop**] Alarm output is off and the status is inactive.

[**Status**] The current alarm output status.



*Note: some models do not have alarm output, please refer to some relative data sheet.*

## 6.4.4 Abnormal Alarm

Provide multiple equipment abnormal monitoring function, and it can do the corresponding alarm linkage of equipment abnormal events.

[**Main Menu**]-[**Event**]-[**Abnormality**] Enter the configuration interface as shown in the figure below:

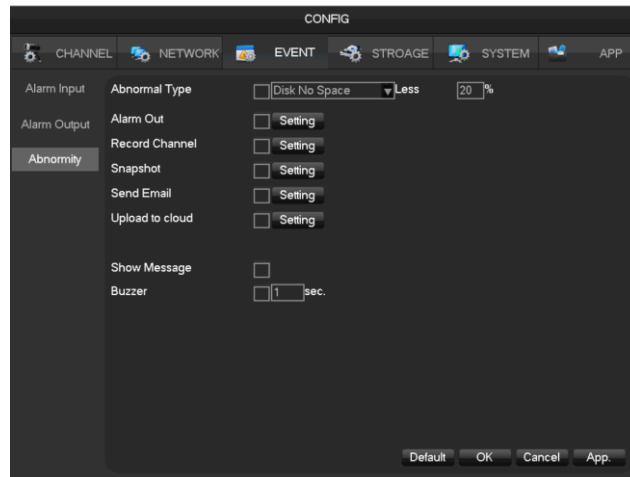

### [Exception type]

[**No Disk**] Alarm when HDD is not present or cannot be detected.

[**Disk Low Space**] Alarm when hard disk capacity is lower than setting.

[**Network Failure**] Alarm when network is not connected.

[**IP Conflict**] Alarm when IP address conflict.

[**Disk Error**] Alarm when there is error in reading and writing hard disk.

[**Alarm Output**], [**linkage record**], [**snapshot**], [**Send Email**], [**show message**], [**Send to network drive**],

[**buzzer**] Show in the appendix 9.1 about set alarm linkage.

## 6.5 Log in/Log out

### Log in

Right click to log in menu. Enter username and password.

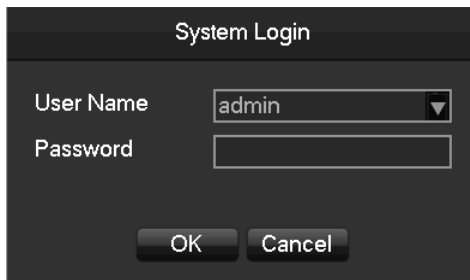

A screenshot of a 'System Login' dialog box. It has a dark background with white text. At the top, it says 'System Login'. Below that, there are two input fields: 'User Name' with a dropdown menu showing 'admin' and a small downward arrow, and 'Password' with an empty text box. At the bottom, there are two buttons: 'OK' and 'Cancel'.

Default users

| User Type     | Name    | Default Password |
|---------------|---------|------------------|
| Administrator | admin   | 123456           |
| User          | user    | 123456           |
| Hidden        | default |                  |



*If enter error password more than 6 times, the DVR/NVR will beep, and the account will be locked. Shut down the device then re-power it or leave the device about 5 minutes, the account will unlock automatically. To be safety, we recommend you to modify the password before settings.*

### Log out

1. When over the standby time, log out automatically.
2. Enter [Main Menu]-[Shutdown]-[Log out].

## 6.6 Preview

### 6.6.1 Live Preview

In live monitoring, there are date, time, channel name, recording status and alarm status.





Control screen switching by front panel, remote controller and mouse.

When alarm occurs, it will show message like external alarm, video loss, video blind, motion detect, network status and IP address conflict.









### Quick Operation

|                                   |   |
|-----------------------------------|---|
| Switch single or multiple screens | Double left click in screen to single channel and Double left click to return         |
| Adjust channel order              | Drag the channel to the wanted position   |
| Add device                        | Click [+] in one channel to enter add menu. Please refer to 6.3.2 about more details. |

## 6.6.2 Channel Toolbar

When mouse move on the top of windows,it will show channel toolbar as follows:



-  Instant playback in five minutes, playback time can be set in menu [SYSTEM]-[Toolbar].
-  Realtime Backup, backup the last 5min video to U-disk, backup time can be set in menu [SYSTEM]-[Toolbar].
-  Snapshot and backup to U-disk.
-  Channel toolbar is temporarily closed within 30 seconds.
-  Set the volume of sound.
-  Set the bothway talk.

## 6.6.3 Right Click Menu

Enter real-time monitoring and right click menu.

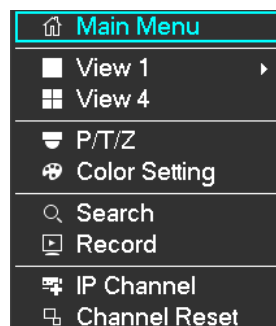

## Screen Division

Choose single screen, four screens, nine screens or sixteen screens to view.

## PTZ Control

Configure PTZ. Please refer to 7.2.4 and 6.3 about more details for analog camera and IP camera.



After done configuration, click “PTZ Control” in corresponding channel to control PTZ.



Direction, steps, zoom, focusing, iris, preset points, cruising between points, patrols, sweeping the boundary, calling an auxiliary switch, light switch, horizontal rotation of PTZ can be controlled.

**[Direction]** Support 8 directions.

**[SIT]** means quick location button. Make sure that the protocol supports this function. After enter the page, click a point in screen. PTZ will turn to the point and move the point to center of screen. Besides, It also supports 4 to 16 times zooming when drag mouse in the quick location page.

The **[Step]** is mainly used to control directions. The figure can be set from 1 to 8. Click  or  to adjust zooming, sharpness and brightness.

PTZ can control eight directions. But front panel only can control up, down, right, left.

**[Present]** Enter present figure in box and click “Present” button to call present function.

**[Tour]** Enter cruise figure in box and click “Cruise” button to call cruise between points function.

**[Pattern]** Enter patrol figure in box and click “Patrol” button to call patrol function.



:gray button means don't support the function.

## Configure [Present]

Present is for recording the next position, which is marked by a figure. Call the figure to enable present function.

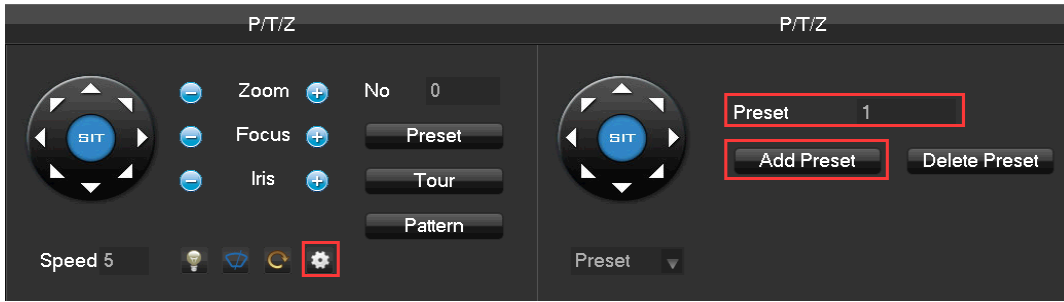

### Configure [Tour]

Tour includes several present points and is marked by a figure. When call the figure, present point will run one by one.

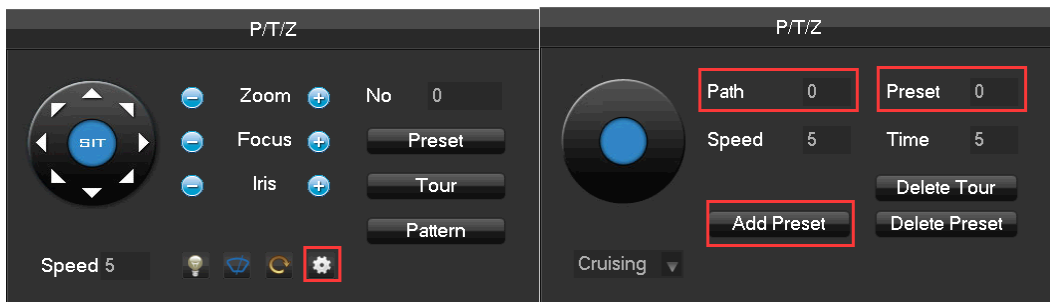

### Configure [Pattern]

Pattern is consisted of PTZ rotation path and is marked by a figure. Call the figure to enable patrol function.

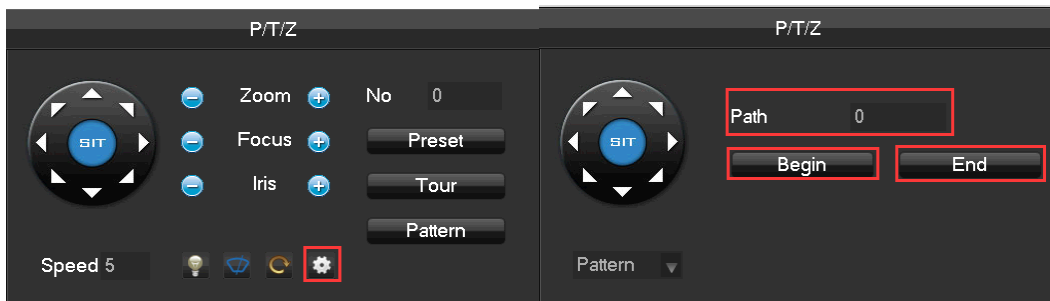

### Color Setting

Adjust the specified screen (single screen) image color hue, brightness, contrast, saturation, gain and white-level parameters set two time periods according to the local environment difference between day and night for each adjustment period set, the device will automatically switch to the best video quality.



**[Period]** Two periods can be set according to ambient light during the day and night, device will automatically switch configuration time. Need to select the Enable box.

**[Hue]** Adjust according to image color cast

**[Brightness]** Visual image brightness, according to the environment, reduces or increases the brightness of the image brightness to make the image relatively clear.

**[Contrast]** Adjust image of black and white in proportion, the greater ratio, the brighter image.

**[Saturation]** Image color purity, the greater value, the more colorful images.

**[Sharpness]** It reflects the image sharpness and edge sharpness of image. The higher the sharpness, the contrast of the details on the image is higher.

**[Noise Reduction]** Reduce the picture noise levels, the higher the level, the less noise, but the sharpness will be lower.

**[Color Mode]** Support Standard mode and Gorgeous mode.

**[Image Mode]** Support Real mode and Transparent mode.



*Note: [Noise Reduction] only work for analog channel. Different mode different function*

## The Video Inquiry

Refer to 6.7 Search.

## Manual Record

In real-time monitoring screen, right click and select **[record]** to enter the interface.

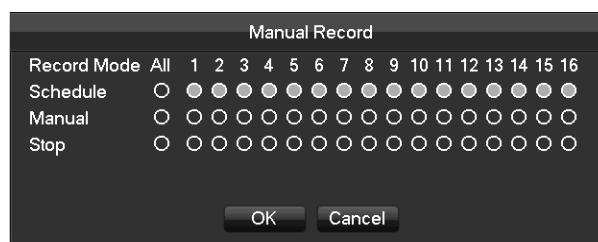

**[Manual]** It has the highest priority and corresponding channels will record for whole days after chosen.

**[Schedule]** Record according to recording configuration.

**[Stop]** Stop recording.

To change a channel state of the video, at first check the video channel state is in selected or not, then use the mouse to click, or use [◀] and [▶] to find the channel and use [▲] and [▼] to switch the video channel state.



*Note: Select all channels and enable can change the video state of all channels at the same time.*

### **IP Channel**

Refer to 6.3.3.

### **Reset the channel order**

Click to reset the default channel order.

## **6.6.4 Task Bar**

Enter from the main menu and provide some quick operation.



### **The Screen Switching**

To implement screen switch function



Above single, four, nine and sixteen channel.

### **View Favorites**



Support add and manage the views. Support collect channels and switch the channel sequence.

### **PTZ control**



Brings up the PTZ control Menu

Refer to 6.4.2 PTZ control of the right-click menu.

### **Record Search**



Click to select the Searching interface

Refer to 6.7 Search

### **Manual Record**



Click to select manual record interface. Refer to 6.6.3 Manual record of the right-click menu.

## NET Channel Management

 Click to enter Net channel interface

Refer to 6.3.3

## Alarm Status

 Check the recent alarm status, click to show the following alarm message

| Alarm Status |   |
|--------------|---|
| Alarm In     | <input type="checkbox"/> 1 <input type="checkbox"/> 2 <input type="checkbox"/> 3 <input type="checkbox"/> 4 <input type="checkbox"/> 5 <input type="checkbox"/> 6 <input type="checkbox"/> 7 <input type="checkbox"/> 8 <input type="checkbox"/> 9 <input type="checkbox"/> 10 <input type="checkbox"/> 11 <input type="checkbox"/> 12          |
|              | <input type="checkbox"/> 13 <input type="checkbox"/> 14 <input type="checkbox"/> 15 <input type="checkbox"/> 16 <input type="checkbox"/> 17 <input type="checkbox"/> 18 <input type="checkbox"/> 19 <input type="checkbox"/> 20 <input type="checkbox"/> 21 <input type="checkbox"/> 22 <input type="checkbox"/> 23 <input type="checkbox"/> 24 |
| Video Lost   | <input type="checkbox"/> 1 <input type="checkbox"/> 2 <input type="checkbox"/> 3 <input type="checkbox"/> 4 <input type="checkbox"/> 5 <input type="checkbox"/> 6 <input type="checkbox"/> 7 <input type="checkbox"/> 8 <input type="checkbox"/> 9 <input type="checkbox"/> 10 <input type="checkbox"/> 11 <input type="checkbox"/> 12          |
|              | <input type="checkbox"/> 13 <input type="checkbox"/> 14 <input type="checkbox"/> 15 <input type="checkbox"/> 16   |
| Mask         | <input type="checkbox"/> 1 <input type="checkbox"/> 2 <input type="checkbox"/> 3 <input type="checkbox"/> 4 <input type="checkbox"/> 5 <input type="checkbox"/> 6 <input type="checkbox"/> 7 <input type="checkbox"/> 8 <input type="checkbox"/> 9 <input type="checkbox"/> 10 <input type="checkbox"/> 11 <input type="checkbox"/> 12          |
|              | <input type="checkbox"/> 13 <input type="checkbox"/> 14 <input type="checkbox"/> 15 <input type="checkbox"/> 16   |
| Motion       | <input type="checkbox"/> 1 <input type="checkbox"/> 2 <input type="checkbox"/> 3 <input type="checkbox"/> 4 <input type="checkbox"/> 5 <input type="checkbox"/> 6 <input type="checkbox"/> 7 <input type="checkbox"/> 8 <input type="checkbox"/> 9 <input type="checkbox"/> 10 <input type="checkbox"/> 11 <input type="checkbox"/> 12          |
|              | <input type="checkbox"/> 13 <input type="checkbox"/> 14 <input type="checkbox"/> 15 <input type="checkbox"/> 16   |
| Network      | <input type="checkbox"/> <input type="checkbox"/>   |
| IP Conflict  | <input type="checkbox"/> <input type="checkbox"/>   |

## Shutdown

 Menu logout, device shutdown, system reboot.

## Intelligent window switch

 Intelligent window switch

When the system is face/perimeter analysis status, click to close the intelligent window in the right side of real-time monitoring screen and click again to open it.

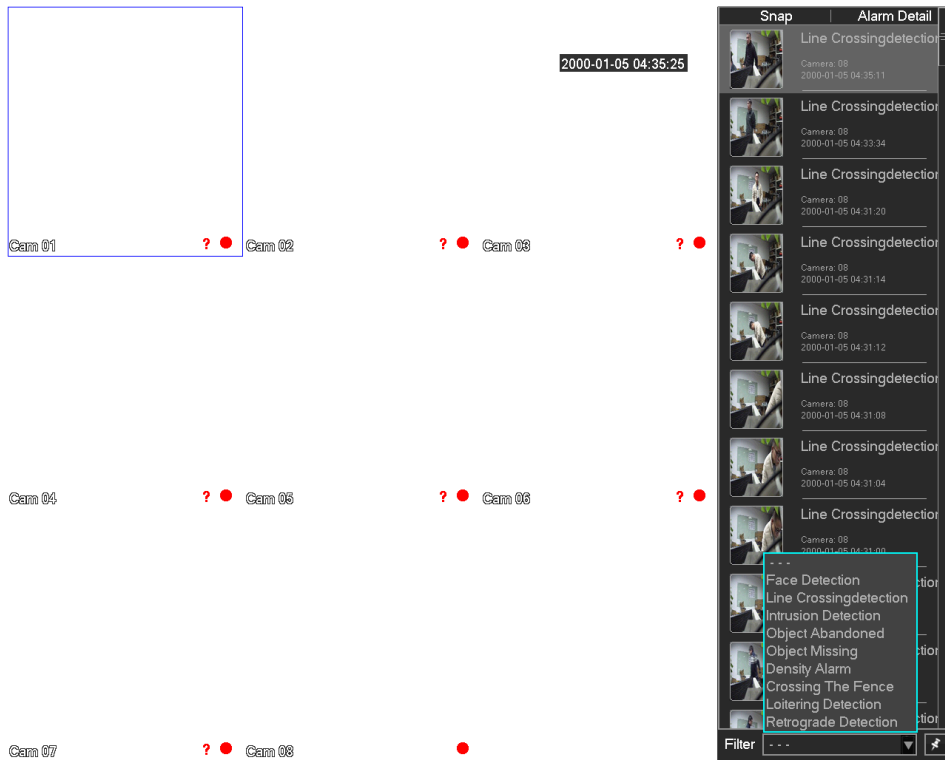

**[Filter]** Events filter: Face detection, Line Crossing detection, Intrusion detection, Object abandoned, Object missing, Density alarm, Crossing the fence, Loitering detection, Retrograde detection.

 Tag the event.

### Conceal function

 Color setting

Refer to 6.4.2 Color setting of the right-click menu.

 Reset the channel order

Click to reset the default channel order.

 Taskbar Configuration

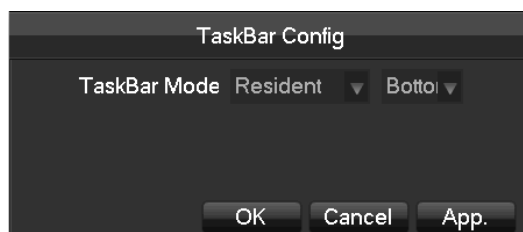

**[Taskbar Mode]** Chose the taskbar resident or automatically, and display at Bottom or TOP.



## 6.7 Search

### 6.7.1 Search

In real-time monitoring screen, right click and select **[search]** to enter the searching interface.

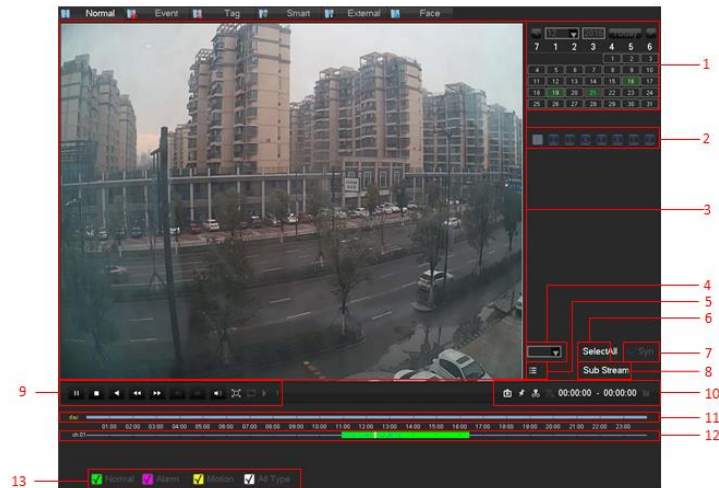

#### Record Search interface description:

| Index | Type               | Description   |
|-------|--------------------|---|
| 1     | Choose the date    | Select the time and date to search records.   |
| 2     | Select channels    | Choose the channels for querying.   |
| 3     | Playback window    | Playing video.  |
| 4     | Time bar channel   | When you select the number of channels is more than 4, a channel number value for the timeline display        |
| 5     | List               | Show the status information of channels' video recording within one day by green, red, yellow.                |
| 6     | All Channel Select | All select, all cancel  |
| 7     | Synchronization    | Achieve the playback of each channel's record is of synchronization in time and of consistency in operations. |
| 8     | Sub Stream         | Playback with sub stream recording file.  |
| 9     | Playback control   | Full screen, Loop, Stop/Play, Pause, Fast, Slow, Back, Previous Frame, Next Frame.                            |
| 10    | Video Edit Tool    | To realize snap, tag, video cut, etc. functions.  |
| 11    | Event list         | Show all events and time  |
| 12    | Timeline display   | Green, red and yellow colors show the video recording in the one day  |
| 13    | Search Type        | 128 video records are shown in the list.<br>Type: R—normal record, A—alarm record, M—motion detection record. |

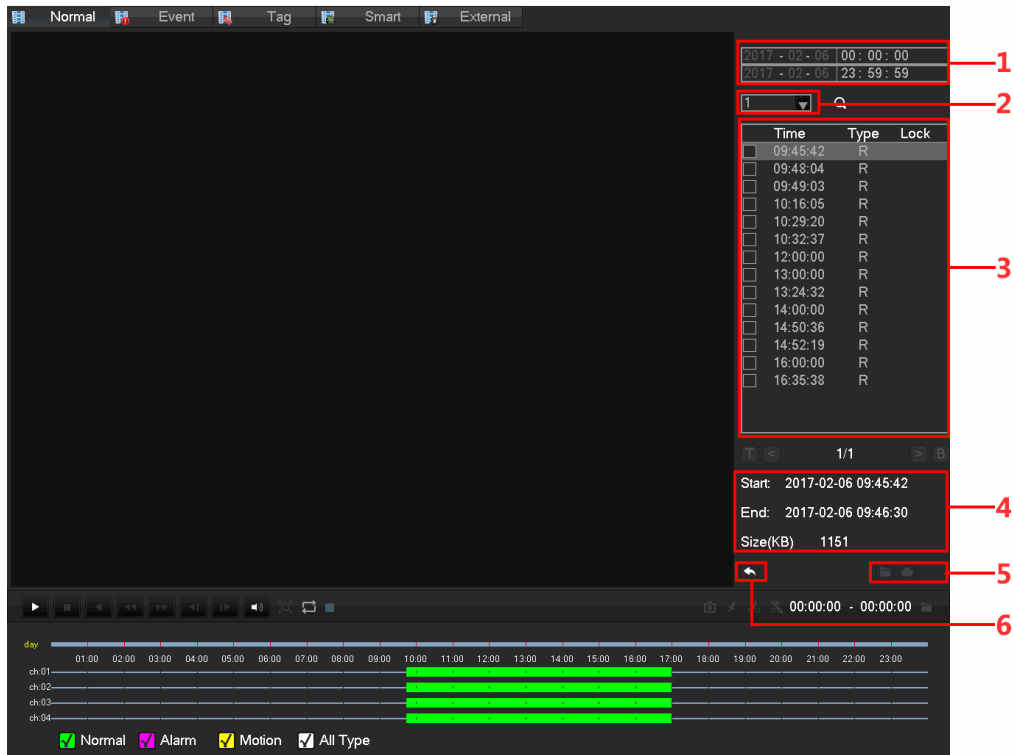













**List:**

| Key | Type             | Description  |
|-----|------------------|--|
| 1   | Time             | Choose video query time  |
| 2   | Channel          | Select the desired query video channel   |
| 3   | File             | Query channel video display a list of files  |
| 4   | File information | Display start time for a single video file, the end time, and video file size.   |
| 5   | Backup           | In the file list box, select the user needs to back up files in the list box playing "📁" to  check, and then click the button (backup) or (uploaded to the cloud disk), the backup operation menu appears, click the Start button, users can also do not want to cancel the backup files in the backup operation menu before you want to cancel the file list box cancel "✓". |
| 6   | Back             | Exit File List   |

**Playback Control:**









| Key   | Description  | Remark                            |
|---|--|-----------------------------------|
| Video playback:<br>Fast-forward Key  | Under playback mode, pressing this key, you can get a variety of fast cycle switching speeds; fast-forward button can be used as slow-release button reverse switch key. | Actual play rate based on version |

|  |  |   |
|--|--|---|
| Video playback :<br>Slow key    | Under playback mode, pressing this key, switch cyclically support a variety of slow-release rate, slow release button can be used as fast-forward button reverse switch key.   |   |
| Play/pause  /  | Play/pause switch when slow-play   |   |
| Backward:<br>Backward key   | Single left click backward key   | To play backwards and single click again to stop back run under common playback Rewind or single-frame playback, press the play button  /  to enter the normal playback . |
| Manual single frame playback<br>  | single frame playback by clicking  and  when common playback pause |   |
| Audio   | Adjust the audio   |   |
| Full screen   | Full screen  |   |
|    | When the loop is turned on, the day after the end of the video playback, video playback file start over again  |   |
|   | Display the current status: normal playback, reverse playback, fast playback level, etc.   | Just display the status, can't set.   |



1. The player playback control bar shows file playback speed, channel, time, playback progress and other information.
2. Playback speed and rewind function are related to DVR version, and please prompt on the player panel shall prevail.

### Video edit button:

| Key  | Description   | Remark  |
|--|---|---|
| Snapshot:<br> | When Playback, left-click on the icon, the snapshot of focus on window will back up to the U disk   | Insert U disk, enter Search , supports a maximum resolution of 1080P  |
| Tag:<br>      | Left-click the icon, you can add tags to focus channel  | set the tag name letters, numbers, special characters, the total length of no more than 31 characters. The tags can be used to add labels to retrieve.  |
| Cut:<br>      | Left click  , start to cut record, Starting time: click  focus window, icon turn to  ; left click again  complete cutting, End time: click  focus window. After finish cutting, click  to back up record, or right click to exit cut feature. | If the focus of the shearing process channel change, places the focus of the channel when the end of the shear cut as a video channel. Shearing process can playback control.<br>When the cut end time is earlier than the start time cut, cut start time |

|  |  |                         |
|--|--|-------------------------|
|  |  | automatically reversed. |
|--|--|-------------------------|

### 6.7.2 Event Search

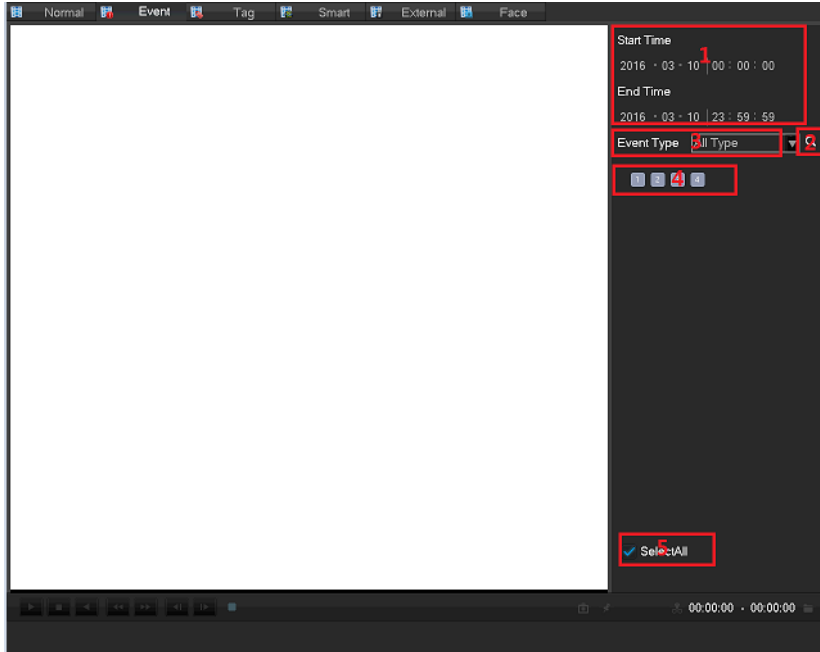

| Index | Type              | Description                                   |
|-------|-------------------|---|
| 1     | Play Timeline     | Display the progress bar of the current event |
| 2     | Search            | Search recording                              |
| 3     | Event Type        | Select the type of event                      |
| 4     | Channel selection | Select the channel                            |
| 5     | Select al channel | Select al channel                             |

Select the channel, start time, event type, click on the retrieval button to pop up a list of events as shown below

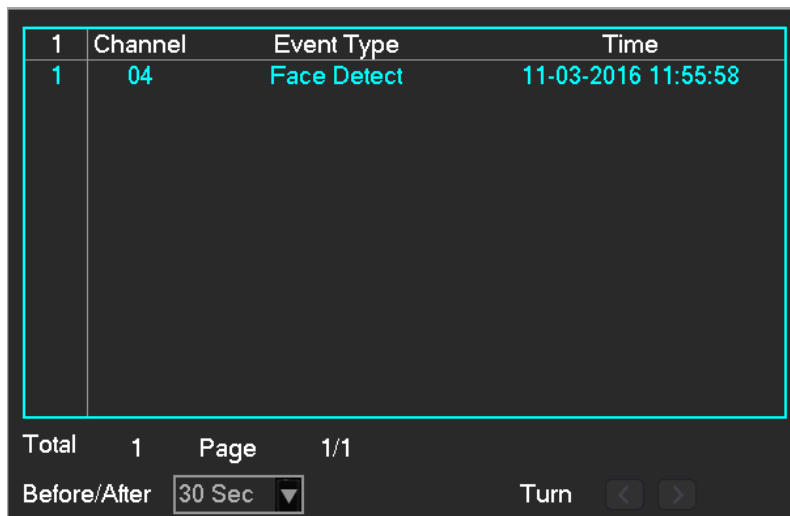

Event List Showing 10 events, to display the event channel number, event type, time, time of occurrence.

List of events can flip through page keys. Double-click the event list for playback directly.

The default time of 30 seconds before and after the event to play video files, can be configured to around 30 seconds, 1 minute, 5 minutes, 10 minutes

### 6.7.3 Tag Search

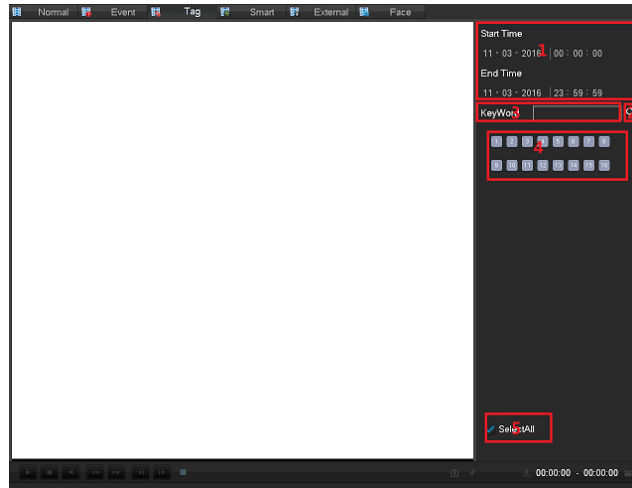

| Index | Type              | Description                                   |
|-------|-------------------|---|
| 1     | Play Timeline     | Display the progress bar of the current event |
| 2     | Search            | Search recoding                               |
| 3     | Event Type        | Select the type of event                      |
| 4     | Channel selection | Select the channel                            |
| 5     | Select al channel | Select al channel                             |

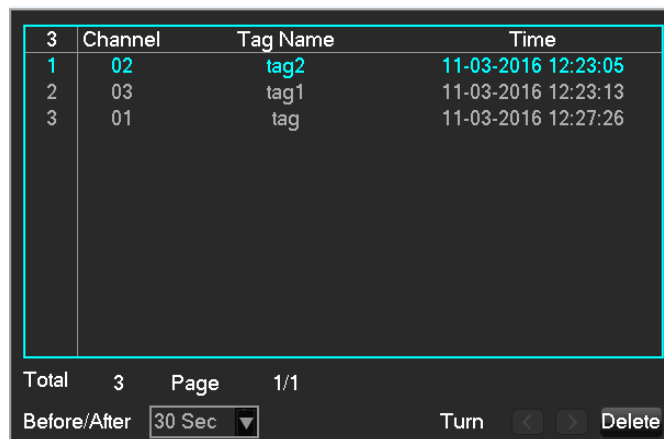

### 6.7.4 Smart Search

Intelligent playback that video playback time, according to the input retrieval conditions, video analysis, quickly locating the qualified video, and playback.

Currently our DVR, TVR device supports retrieval based on intelligent motion detection playback area.

Enter the smart playback interface, the interface as shown in FIG.

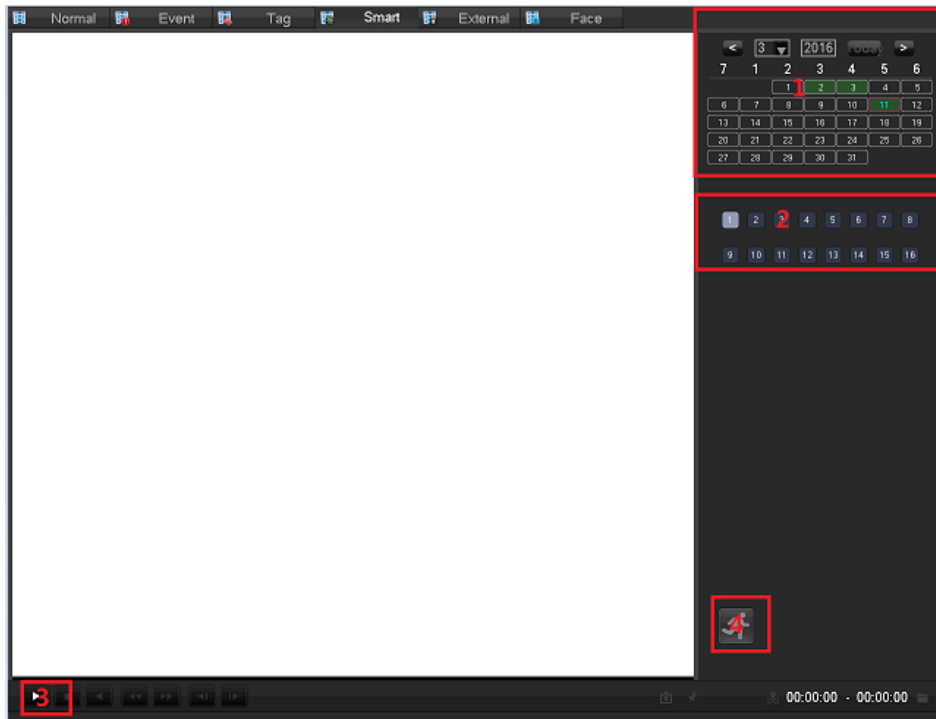

Intelligent playback using the following process

1. Position 1, select the desired search date.
2. Position 2, select the desired search channel (radio).
3. Left-click on the third position to start playback.
4. Left-click on the icon position 4, select dynamic inspection area.
5. Full-screen setting area is completed, the right mouse button to exit the configuration. Complete search, video recording shall be the date the presence of all the moving subject information of the channel region is configured to display on the timeline.

## 6.7.5 External Search

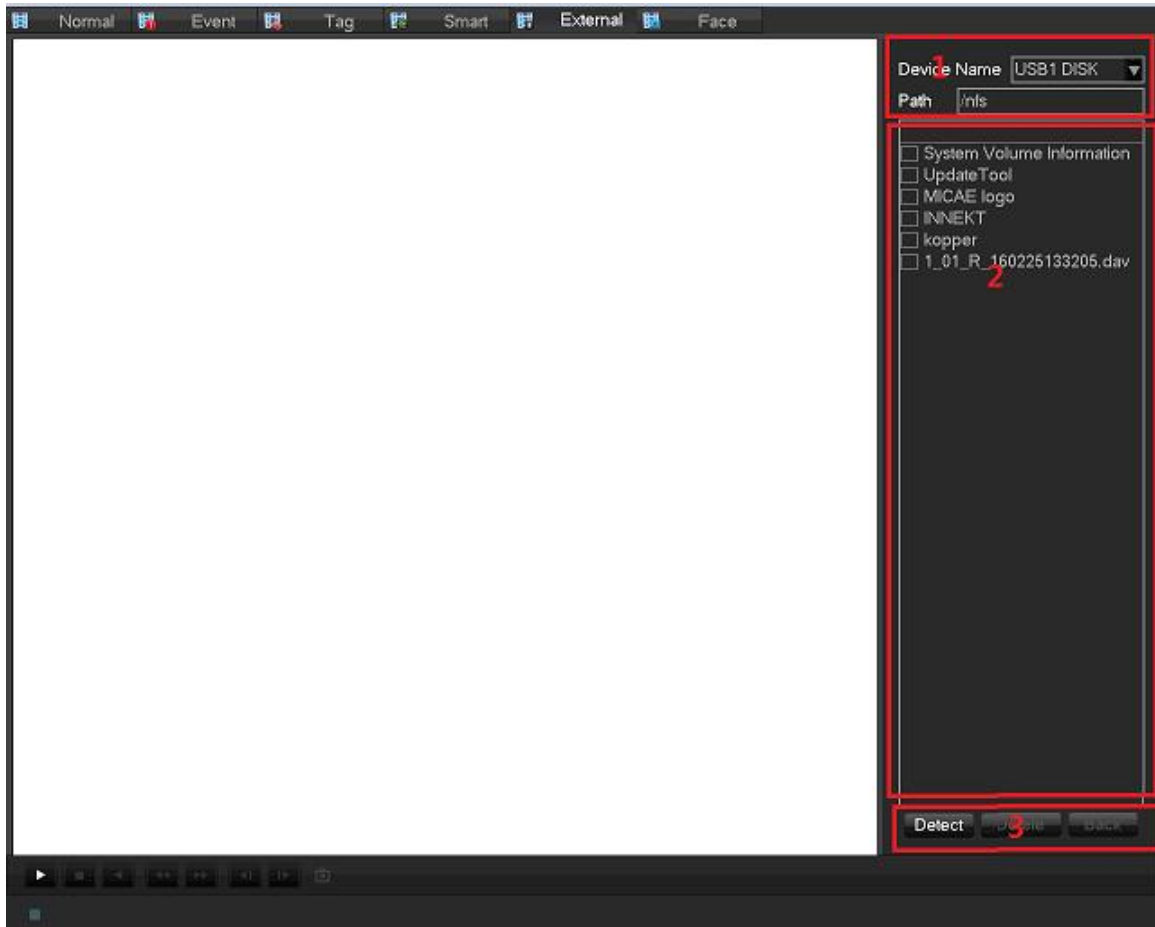

| Index | Type            | Description   |
|-------|-----------------|---|
| 1     | File Path       | Playback of each channel's of synchronization.                            |
| 2     | Folder Contents | Select channels desired to query records.                                 |
| 3     | File Control    | [Device Detect] Left-click the device detects the detection insert U disk |
|       |                 | [Delete] Left click, delete the file                                      |
|       |                 | [Back] Click the left mouse button to return to the previous folder       |

## 6.7.6 Face search

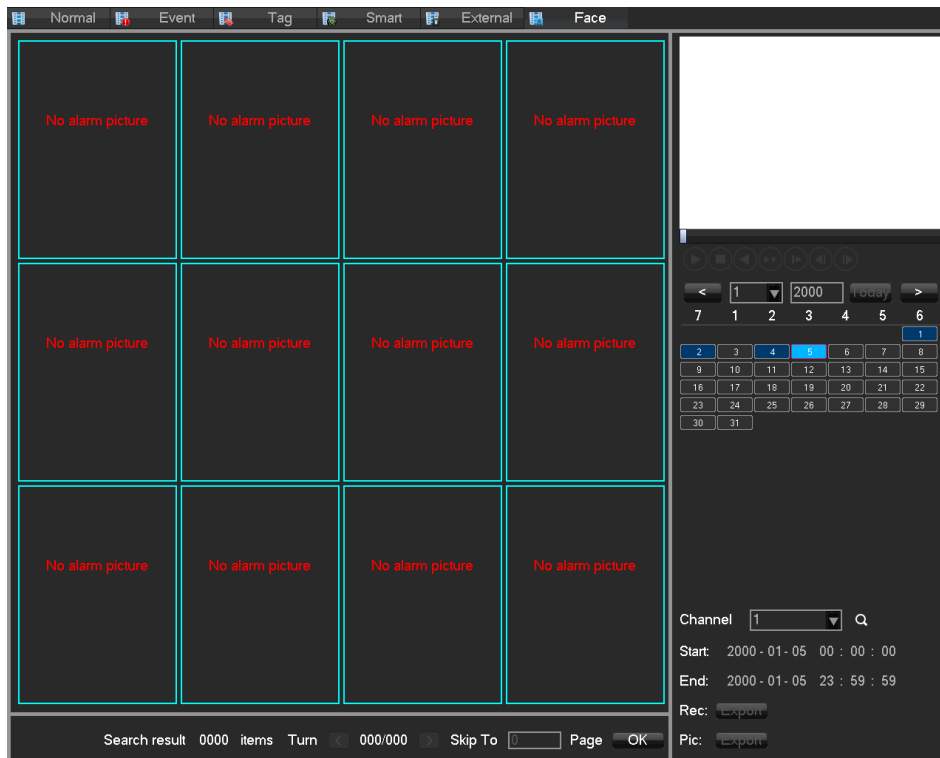

| Index | Type             | Description   |
|-------|------------------|---|
| 1     | Play windows     | Play the video.   |
| 2     | Play Timeline    | Display the progress bar of the current event   |
| 3     | Playback control | Stopping / playing, pausing, fast playing, slow playing and the previous/next frame on a suspended state. |
| 4     | Calendar         | Select the date to search records.  |
| 5     | Face list        | Show the all face images of the channel in the query time.  |
| 6     | Channel number   | Select the channel number.  |
| 7     | Search           | Click to search out record files.   |
| 8     | Time Search      | Search the records based on the starting time and end time.   |
| 9     | Face Statistic   | Display the total number of face images and pages of the channel in the query time .                      |
| 10    | Page number      | Display the current page and the total number of pages.<br>Page up and page down.                         |
| 11    | Export           | Export all the face images of the current page..  |
| 12    | Process          | The process of backup   |



## 6.8 Record Backup

### Interface Description

Connect an External USB device with the USB port to backup file in the **[Record Backup]** menu.

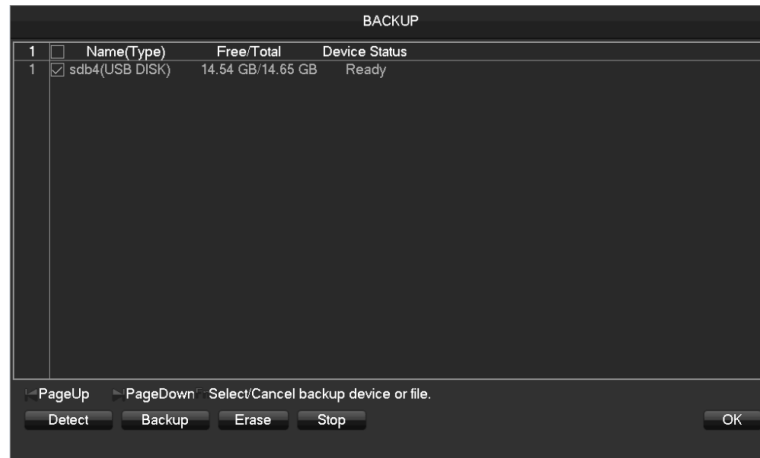

**[Detect]** Identify external USB device and display the device information.

**[Backup]** Tick the external device and click **[Backup]** to enter the backup menu .

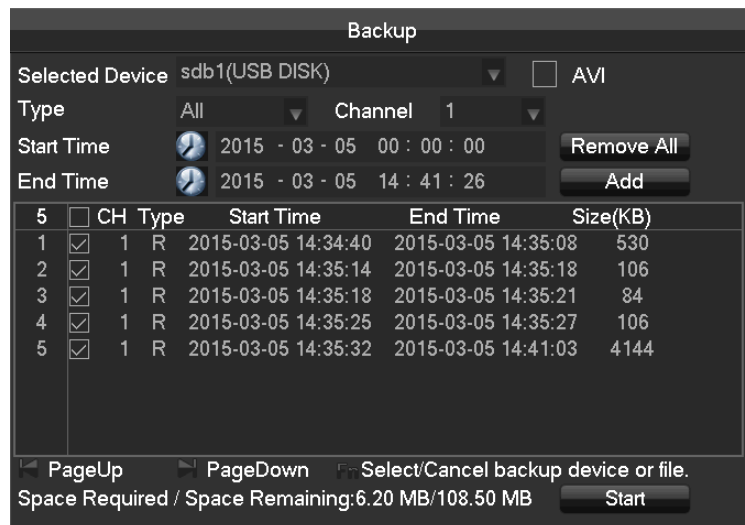

**[Cancel]** Delete all data in USB backup device

### Backup Operations

Connect an External USB device with the USB port, click **[Detect]** to Identify external USB device, click **[Backup]** to enter the backup menu, select the record start -stop time and click to add files in list, click **[Start]** to backup and display time remaining.



*USB backup carry player automatically. This operation probably will cause permanent data loss.*

# 7 Local Configuration

## 7.1 The Introduction of The Main Menu

The main menu is shown as the following interface:

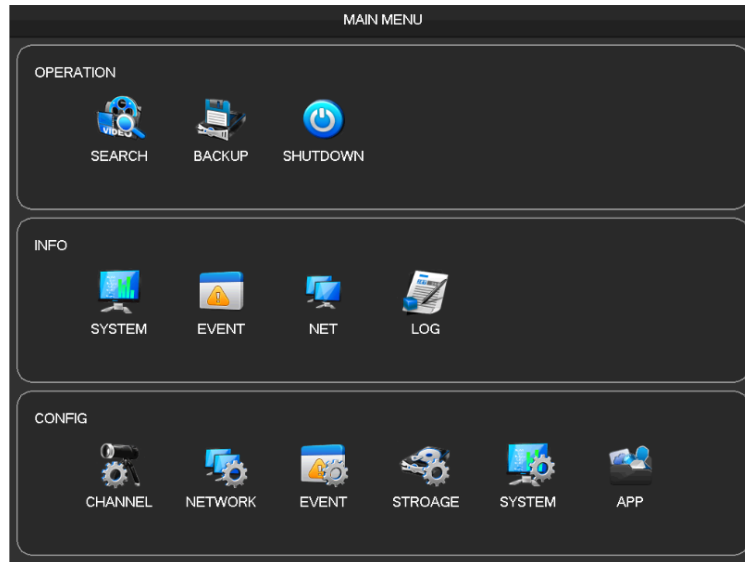

### Operation

**[Search]** Based on time, time, label, query and playback video files.

**[Backup]** Backup device detection and video data.

**[Shut Down]** User logs off the device, the device shut down and reboot the system.

### INFO

**[System]** Displays the system status, hard drive status, version information.

**[Event]** displays alarm information.

**[Net]** Stream state, the online user information.

**[Log]** System log information.

### Config

**[Channel]** Add / Remove the camera, the camera parameters, the basic parameters of the channel configuration, channel mode switch, channel events and joint management parameters.

**[Network]** Basic network configuration parameters settings, manage network interfaces, configure advanced network services.

**[Event]** External alarm events and abnormal events of the configuration parameters of the device and joint

management.

**[Storage]** Hard disk storage configuration management, video parameter settings, set the record schedule.

**[System]** Configuration System parameters time, date, language configuration, management and video output parameters polling settings.

**[Application Center]**E-mail, P2P, cloud storage, mobile phones and other common functions push settings.

## 7.2 INFO

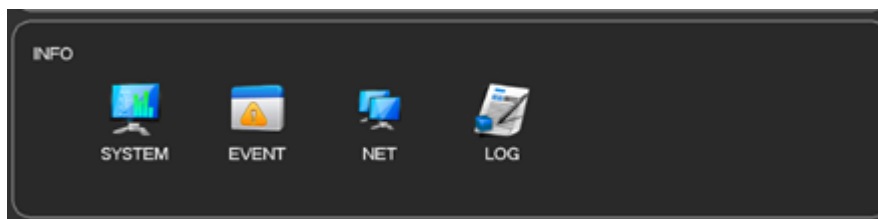

### 7.2.1 System

It displays the current total capacity of DVR hard disk, the remaining capacity and working conditions. As shown below:

#### **HDD Manage**

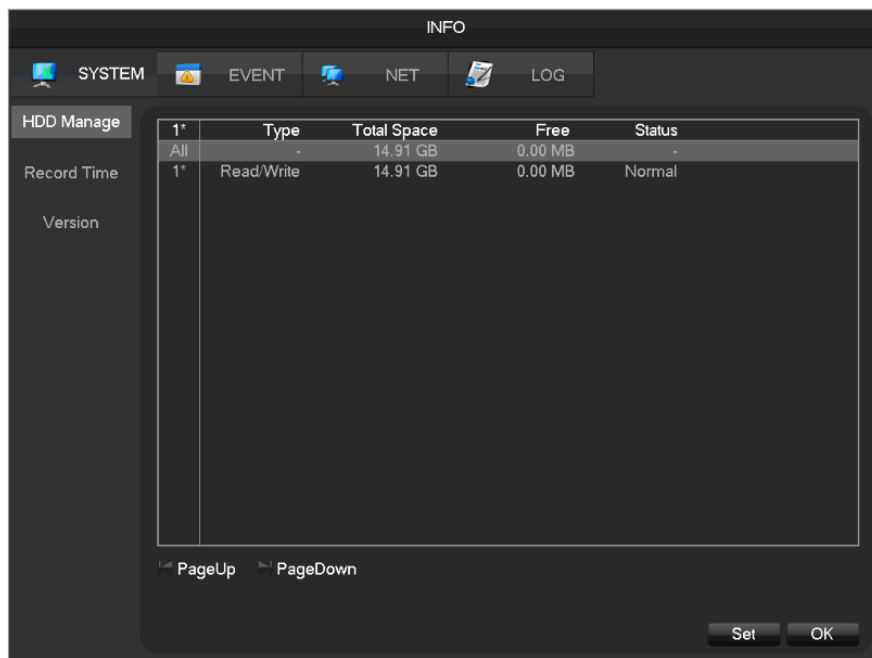

#### **Record Time**

Show starting and ending time of the computer's hard disk recording. As shown below

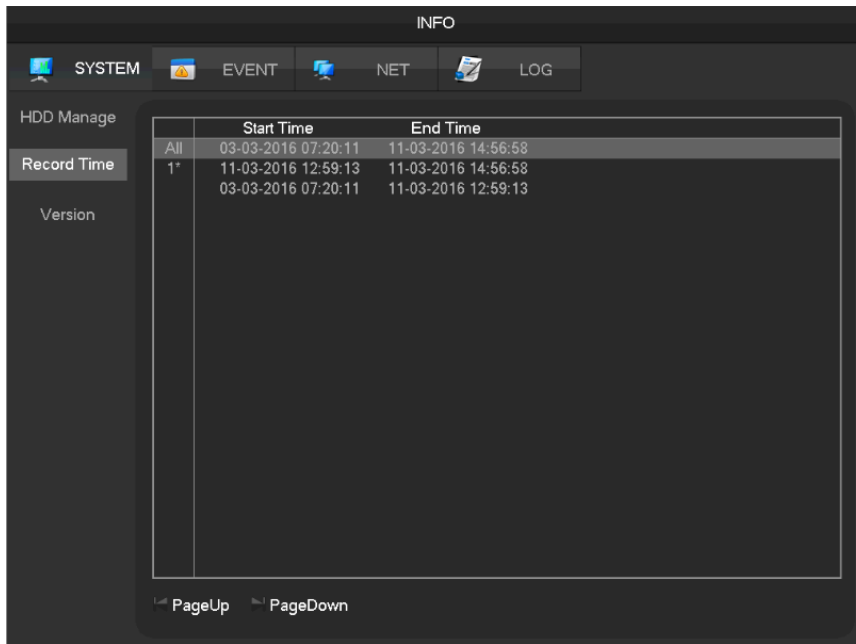

## Version

The display device serial number, system hardware features, software version and release date information.

As shown below

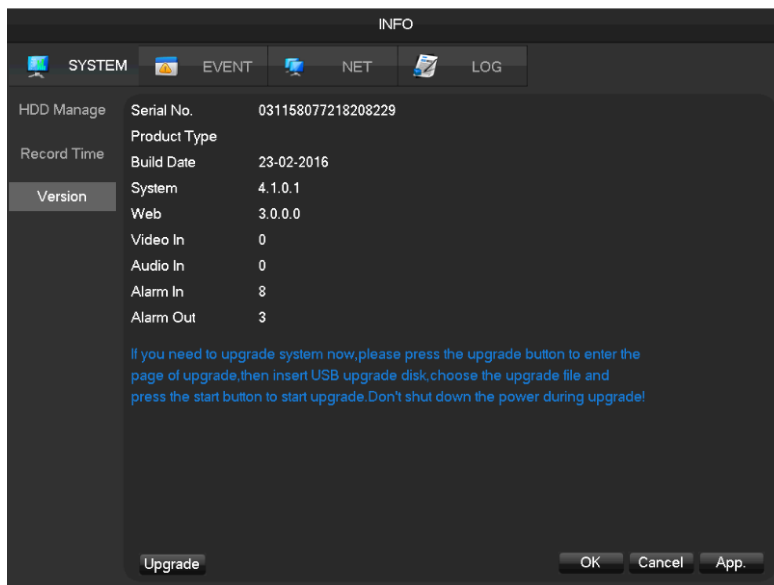

## 7.2.2 Event

Displays the current alarm status

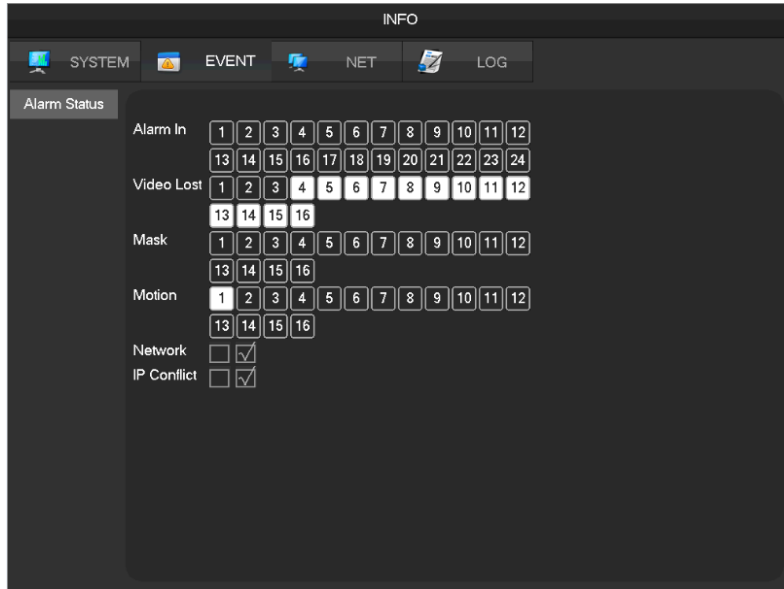



### 7.2.3 Net Information

The equipment with input function use network channel management page for add or delete the equipment and set the front-end configuration.

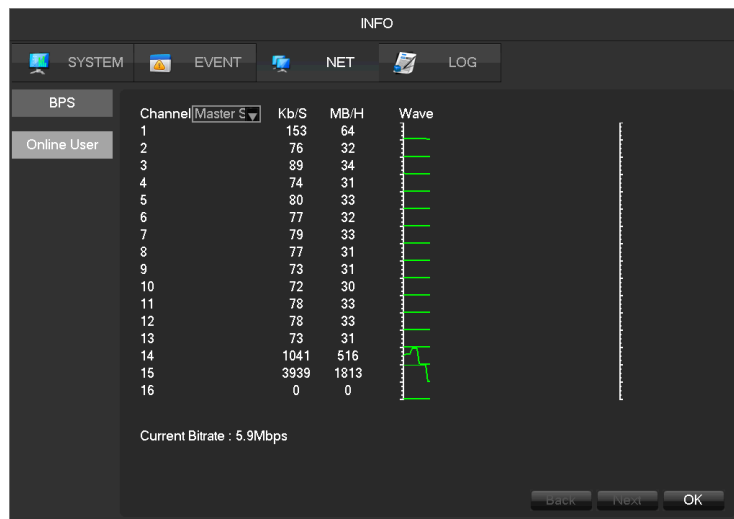
#### **BPS**

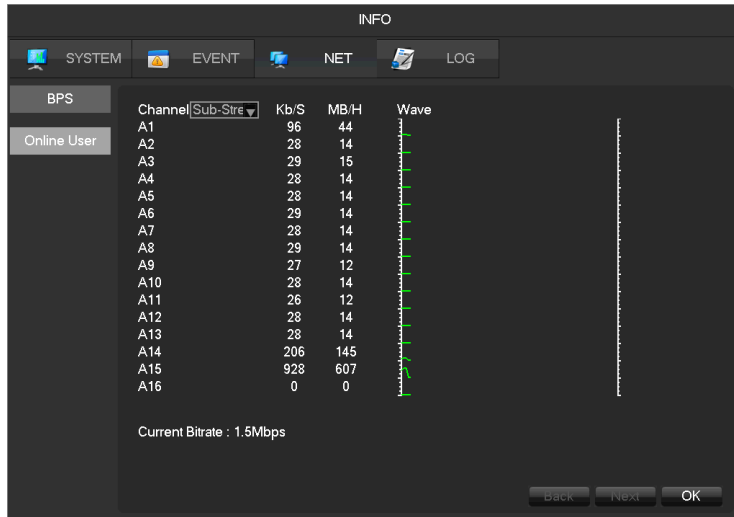



 count the bitrate of each channel, the value is an estimated value.

### Online User

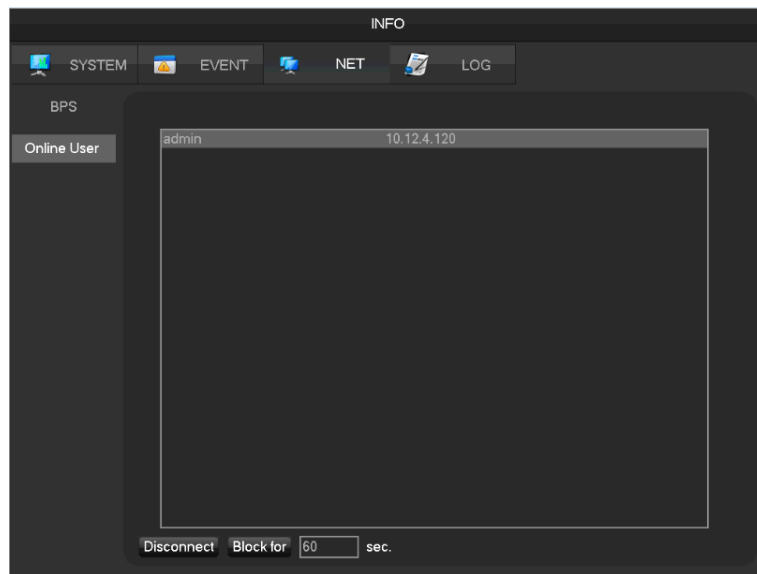

View the current online user status, disconnect and shielding.

## 7.2.4 LOG

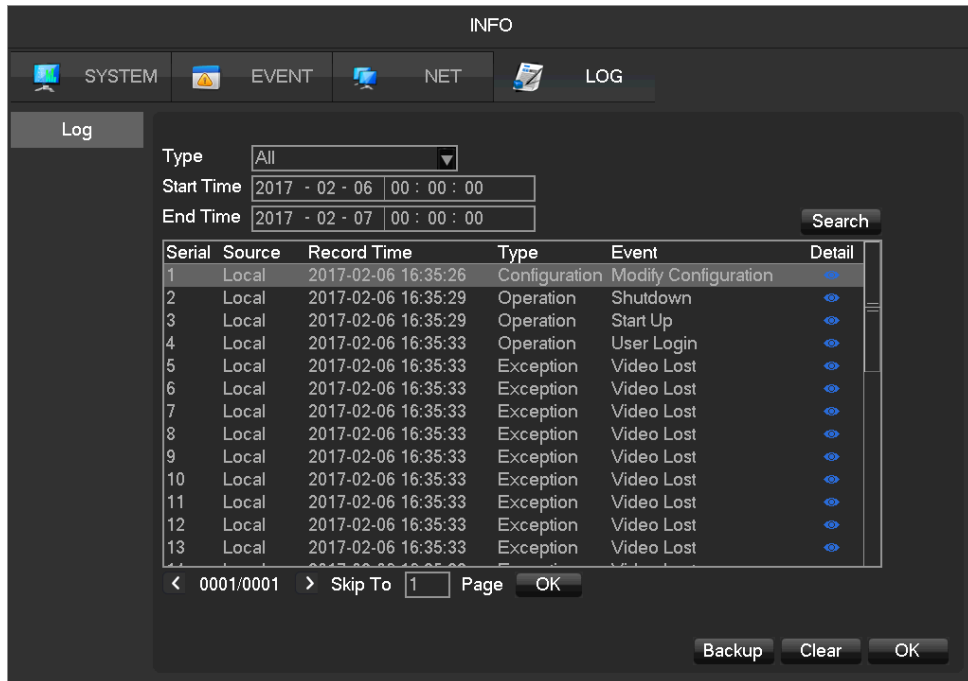

Log information can be divided into system operation, configuration operation, data management, alarm event, recording operation, user management, log clear, file operations.

Select the type and time of the query, press the Find button, the system displays the log as a list, and click the Backup button will log export backup to your computer.

Click the Clear button, the system will remove all types of log files.

## 7.3 CONFIG

### 7.3.1 Channel Setting

#### IP Channel

The operations to add / delete IPCs into NVR refer to 6.3.3 IP Channel Management.

#### Base

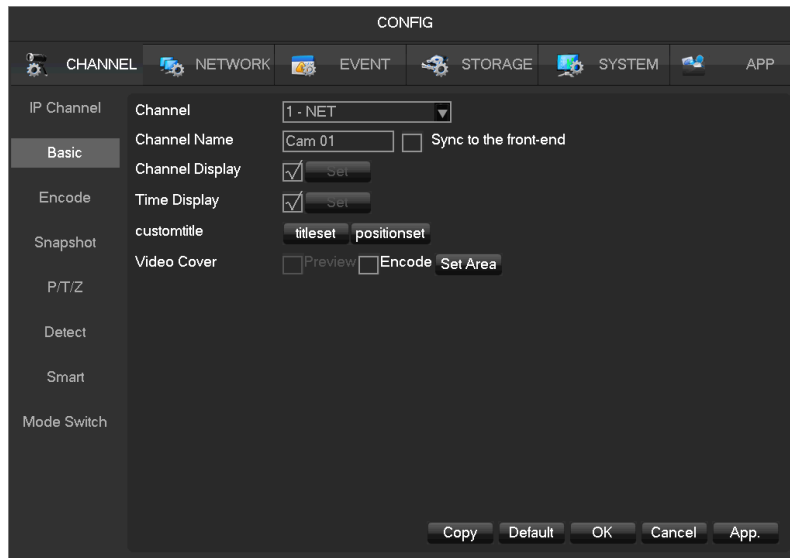

**[Channel]** Choose the channel no. which needs setting.

**[Channel Name]** Set the channel name if in need.

**[Channel Display]** Set the channel name's display place on the picture.

**[Time Display]** Set the time's display place on the picture.

**[Time Synchronization]** Synchronize the time with net channel and device.

**[Video Cover]** Set some special area which needs special protection while preview and recording.

## Encode



**[Channel]** Choose which channel to set.

**[Compression]** H.264/H.264+/H.265/H.265+/MJPG.

**[Resolution]** There are multiple resolutions to choose for main stream. Sub steam too. Users can set the



parameter according to their needs.

**[Frame Rate]** PAL: 1fps-25fps; NTSC: 1fps-30fps.



*compression, resolution and frame rate are vary depending on devices and firmware version.*

**[Bit Rate Control]** It includes fixed stream and variable stream. Under fixed stream, user can set encode stream, while under variable stream, user can choose 6 class of image quality, lowest, lower, low, middle level, higher, highest.

## Snapshot

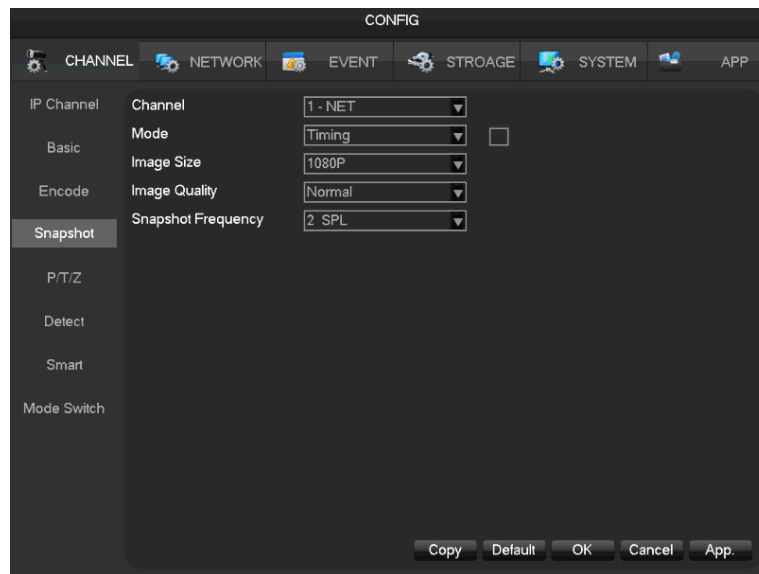

**[Channel]** Select a channel.

**[Mode]** Trigger: Crawl images when alarm. Click to enable the function.

**[Image size]** Choose different resolution for snapshot.

**[Image Quality]** There are 6 levels of quality.

**[Snapshot frequency]** set highest capture rate for single channel, 1/2/3/4/5/6/7/8 s/pc.

## P/T/Z Control

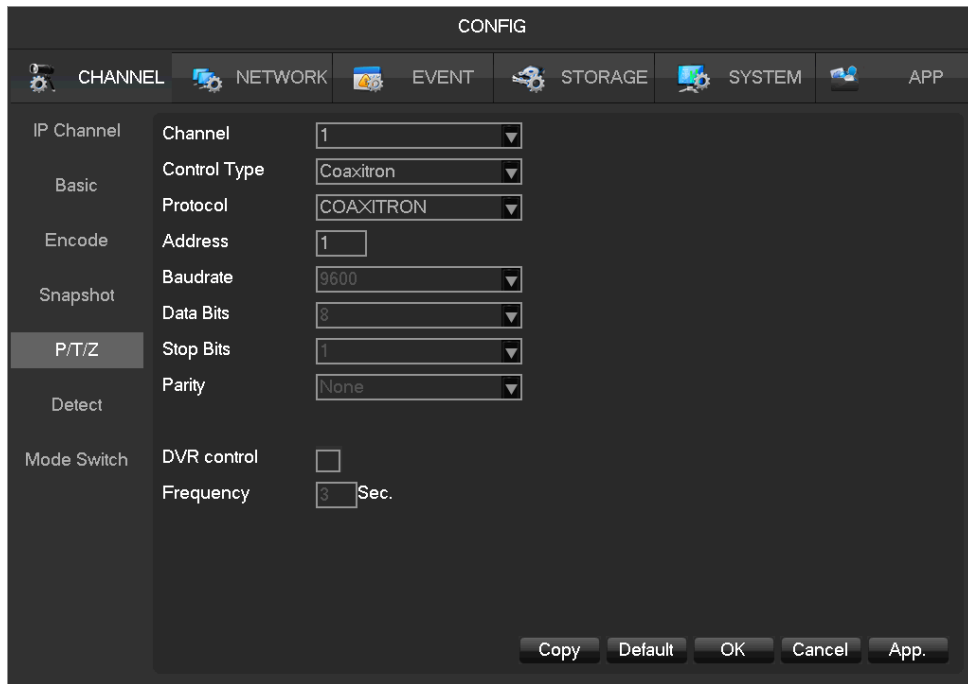

**[Channel]** Select the PTZ channel to set.

**[Control Type]** Chose coaxitron or RS485, based on the channel type.

**[Protocol]** Select the PTZ protocol (e.g. PELCOD).

**[Address]** The PTZ's address.

**[Baudrate]** The PTZ's baudrate, can find it in the PTZ OSD, the default is 9600.

**[Data Bits]** Default is 8.

**[Stop Bits]** Default is 1.

**[Parity]** Default is none.

**[DVR Control]** Enable it can virtual the PTZ features.

**[Frequency]** Default is 3sec. The value range is 1~30secs.

## Detect

Video detection includes motion detection, video lost, video blind. The details refer to 6.4.1.

## Smart

The details refer to 6.4.2.

## Mode Switch

The details refer to 6.3.1 and 6.4.2.

## 7.3.2 Network

This menu section allows you to configure the network settings of the NVR. It is recommended that an experienced network technician should only be able to configure settings in this menu section.

| Category    | Setting              | Value                    |
|-------------|----------------------|--------------------------|
| Basic       | Network Type         | LAN                      |
| Advanced    | DHCP                 | <input type="checkbox"/> |
| Application | IP Address           | 10 . 12 . 4 . 134        |
|             | Subnet Mask          | 255 . 255 . 255 . 0      |
|             | Gateway              | 10 . 12 . 4 . 1          |
|             | AUTO DNS             | <input type="checkbox"/> |
|             | First DNS Server     | 8 . 8 . 8 . 8            |
|             | Alternate DNS Server | 192 . 168 . 1 . 1        |
|             | MAC Address          | e0:61:b2:00:22:9d        |
|             | MTU                  | 1500                     |

### Basic

**[Network Card Type]** LAN1: Default IP is 192.168.1.88;

LAN2: Default IP is 192.168.2.88

LAN2 is used to POE the IP camera. If the IP Camera is connected to the POE, the IP address of IP CAMERA and NVR must be in the same network segment.

**[DHCP]** Enable the NVR to obtain an IP address automatically. If it is enabled, the NVR will reboot and search for a DHCP server, and then assign a dynamic IP address. The dynamic IP address will be displayed in the menu. Enter a static IP address if there is no DHCP service available. If you are using the advanced feature PPPOE, then the IP/mask/gateway and DHCP are unable to be changed.

**[IP Address]** Use (▲▼) or input numbers to modify IP, then set **[subnet mask]** and **[default gateway]** for this IP.

**[AUTO DNS]** Get the DNS from the DNS server automatically.

**[First DNS Server]** DNS server IP address.

**[Alternate DNS Server]** DNS alternate IP address.

**[Physical Address]** Physical address of current net port.

**[MTU]** Default is 1500, range is 128-1500.

## Advanced

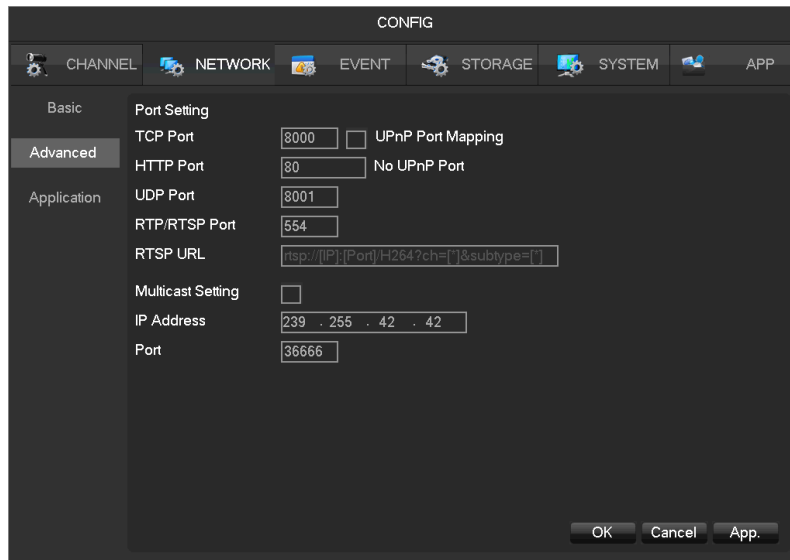

**[TCP]** Default: 8000, variable.

**[HTTP]** Default: 80.

**[UDP]** Default: 8001.

**[RTP/RTSP PORT]** Default: 554.

**[Multicast]** Tick 'Multicast' and set a group in 'Set', IP should be limited as follow picture, port no limit.

## Application

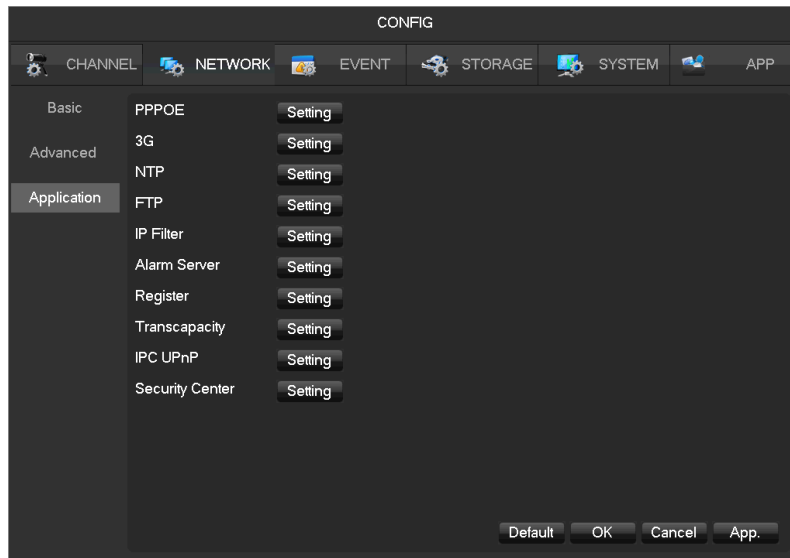

**[PPPOE]** Select Enable switch to turn on the PPPOE dial-up service of the device.

Enter ISP (Internet service provider) provide the saving of user, password for PPPOE.

Operation: Succeed after dialing, check the **[Network Status]**IP, then enter the IP address to access the device after open IE.

**[3G]** Support 3G card dial-up to provide remote access device features.

**3G**

signal intensity .x|

3G TYPE   Enable

APN

dialing number

UserName

Password

IP

OnLine Status The module is not inserted.

SIM Card Not In

[NTP] Select Enable switch to turn on the NTP protocol support, can be with SNTP communication server to realize automatic calibration function.

**NTP**

Server IP   Enable

Port

Update Period  min.

**Host IP:** Enter the IP of NTP service NTP.

**Port:** Supports TCP transport only, port is limited only 123.

**Update cycle:** interval time is 1 minute or more, the maximum update period is set to 65,535 minutes.

**Time Zone:** London GMT+0, Berlin GMT +1, Cairo GMT +2, Moscow GMT +3,

New Delhi GMT +5, Bangkok GMT +7, Hong Kong & Beijing GMT +8, Tokyo GMT +9, Sydney GMT +10, Hawaii GMT-10, Alaska GMT-9, Pacific Time GMT-8, US Mountain Time GMT-7, US Central Time GMT-6, US East Time GMT-5, Atlantic Time GMT-4, Brazil GMT-3, Atlantic – Central GMT-2.

[FTP] Select the Enable box to make the protocol enable, to enter the FTP settings menu.

The screenshot shows the 'FTP' configuration window with the following settings:

- Type: Record FTP
- Server IP: [Empty]
- User Name: [Empty]
- Password: [Empty]
- Remote Directory: [Empty]
- File Length: 0 M
- Channel: 1
- Weekday: Thu
- Time Period 1: 00:00 - 24:00
- Time Period 2: 00:00 - 24:00
- Enable:
- Anonymous:
- Alarm:
- Motion:
- General:

Buttons at the bottom: Copy, OK, Cancel, App.

Two kinds of FTP upload file types are video files and pictures, set up an FTP server address, port, remote directories and so on. When remote directory is empty, the system will automatically create a different folder by IP, time, channel.

User name & password: access the FTP username and password.

Set upload file size, you need to upload the file channel, time, type, etc.

Set upload length which upload to FTP server file length, if less than the set value, the entire video file upload; If more than the set value, upload take part from the beginning and set the value of consistency, the file later omitted; setting a value of 0, then upload the entire video file.

Different channels can be set two different time periods, three types of video recording.

**[IP Permissions]** For permission to access the DVR IP rights management. When choosing the white list, the list indicates that only the IP to connect this DVR. Up to 64 IPs. If the selected item is not ticked, no restrictions on accessing to the device's IP.

### IP Filter

Restricted Type Trusted Sites  Enable

0 . 0 . 0 . 0 Add IP

Delete IP Delete All

OK Cancel App.

[Alarm Center] Alarm interface for customers to reserve the use of self-development.

### Alarm Server

Protocol Type Private  Enable

Server IP 10 . 1 . 0 . 2

Port 0

Everyday at 08:00

OK Cancel App.

[Register] Device connects to the platform automatically.

### Register

Enable

|            |                               |      |                   |        |                          |
|------------|-------------------------------|------|-------------------|--------|--------------------------|
| IP Address | <span>10 . 12 . 2 . 22</span> | Port | <span>4567</span> | Enable | <input type="checkbox"/> |
| IP Address | <span>10 . 12 . 2 . 22</span> | Port | <span>4567</span> | Enable | <input type="checkbox"/> |
| IP Address | <span>10 . 12 . 2 . 22</span> | Port | <span>4567</span> | Enable | <input type="checkbox"/> |
| IP Address | <span>10 . 12 . 2 . 22</span> | Port | <span>4567</span> | Enable | <input type="checkbox"/> |
| IP Address | <span>10 . 12 . 2 . 22</span> | Port | <span>4567</span> | Enable | <input type="checkbox"/> |

OK Cancel App.

[Transcapacity]



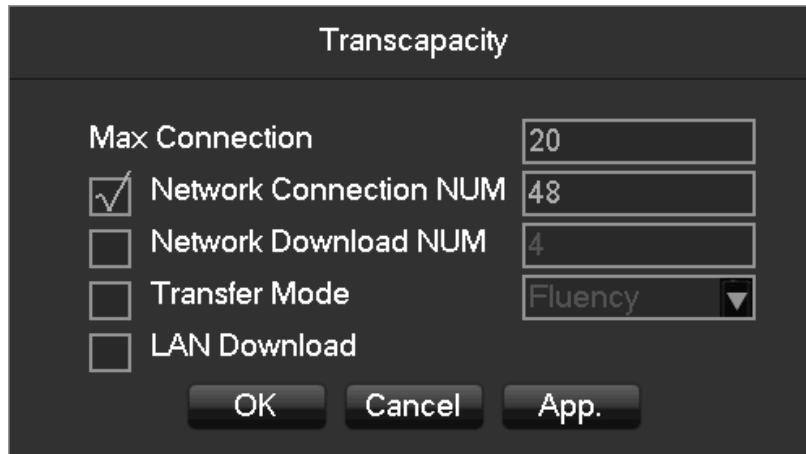

**[Max Connection]** The number of connections: 0-20, if you set 0 means the network does not allow users to connect, the maximum number of connections is 20.

**[Network Connection NUM]** The number of connections defaults to three times the number of channels. Real-time video over the network for browsing, the number of connections depending on network bandwidth, the number greater, the larger the network load, will impact of video playback fluency.

**[Network Download NUM]** The number of connections to download recommendations: 0-8, this need to tick to start this function.

**[Network transmission QOS]** smooth network transmission quality priority or image quality priority or adaptive, depending on the setting, the network adjusts the stream automatically.

## IPC UPnP

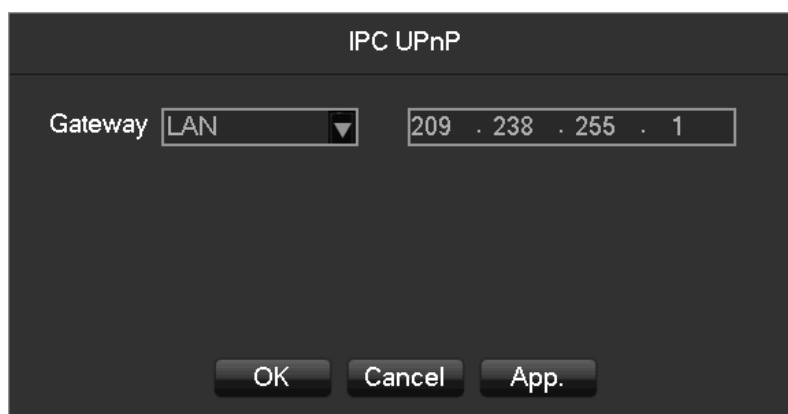

To allocate virtual IP address to our IPC. This is the IP segment.

## Security Center

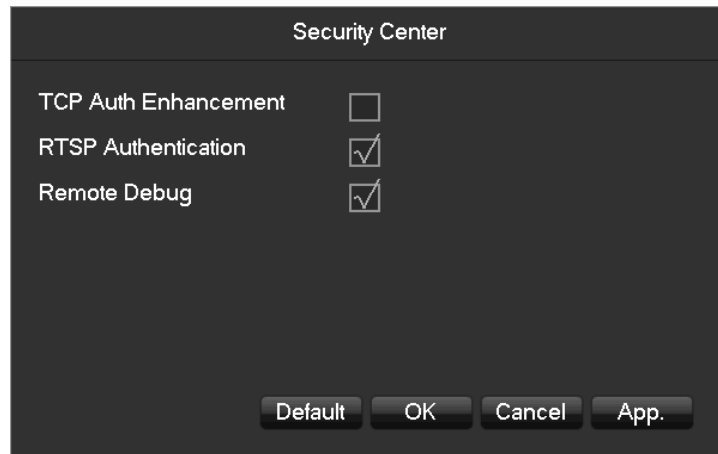

RTSP service, remote debug, TCP auth enhancement switch. Only enable them can work.

### 7.3.3 Event

#### **Alarm Input**

The details refer to 6.4.3.

#### **Alarm Output**

The details refer to 6.4.3.

#### **Abnormality**

The details refer to 6.4.4.

### 7.3.4 Storage

#### **HDD Manage**

Show the HDD space and status.

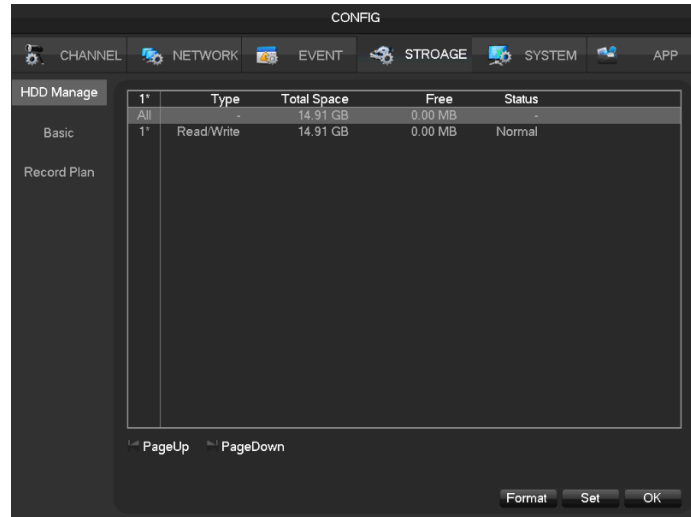

*Note: Hard disk format operation results in the loss of video data.*

**[Set]** Set HDD as read-write, read only or redundancy mode. Video data can be protected from covering under read only mode. It supports HDD S.M.A.R.T smart detection at the same time.

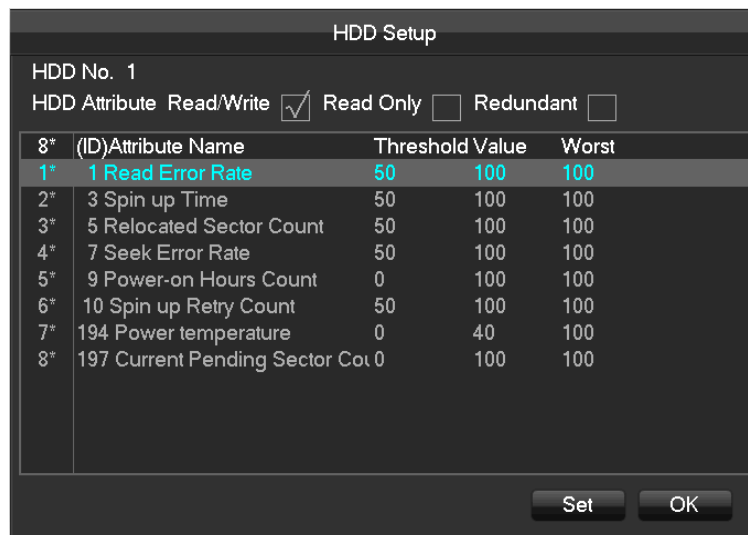

**Basic**

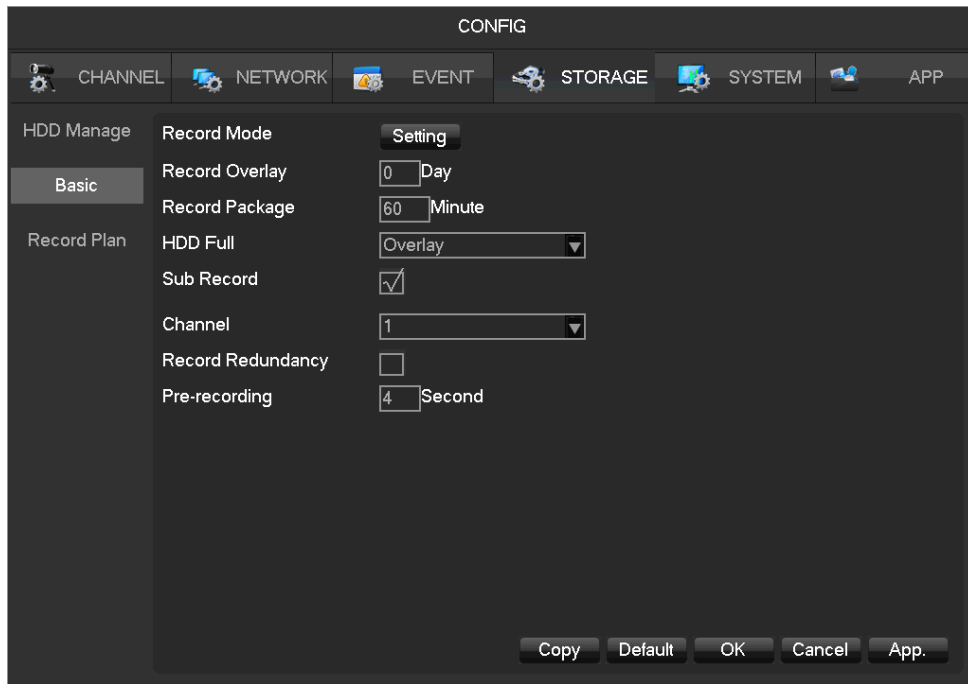

**[Record Mode]** Support three modes, record automatically, manually or not record.

**[Record Overlay]** The range is 0~31.

**[Video Package Time]** The figure is between 5 to 120 minutes.

**[HDD Full]** Overwrite or stop recording.

**[Sub Record]** Sub-stream recording switch. Enable it, then will recording with sub-stream and main stream.

**[Channel]** Select a channel.

**[Video Redundancy]** Open or close the redundant recording.

**[Prerecorded]** The figure is between 0 to 30 seconds.

## Recording plan



**[Channel]** Select a channel. Green shows normal recording, Yellow shows motion detection, and Red shows Alarm. Users can set or change setting according to date.

**[Copy]** Copy the setting to other channels.

Click **[Set]** and enter into plan editing picture

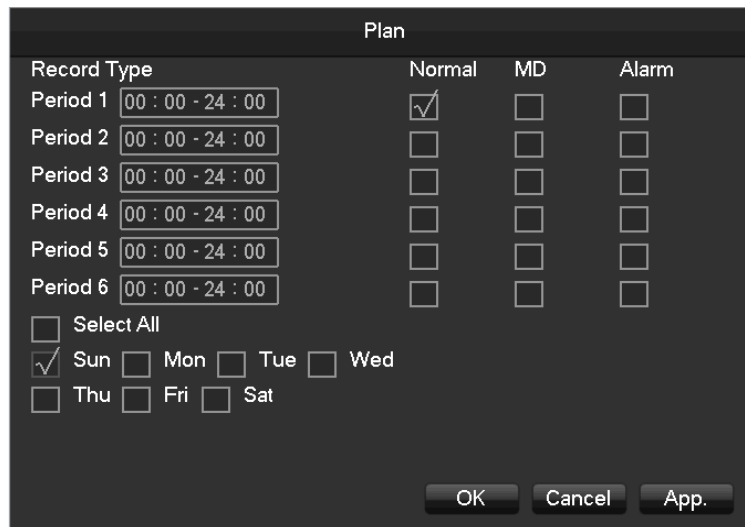

**[Period]** Set the recording period, there will be 6 period to choose.

**[Regular]** Regular recording.

**[MD]** Motion detection recording.

**[Alarm]** Alarm recording.

## 7.3.5 System Configuration

### Basic setting

Get into the **[Basic]** menu under **[Configuration]**

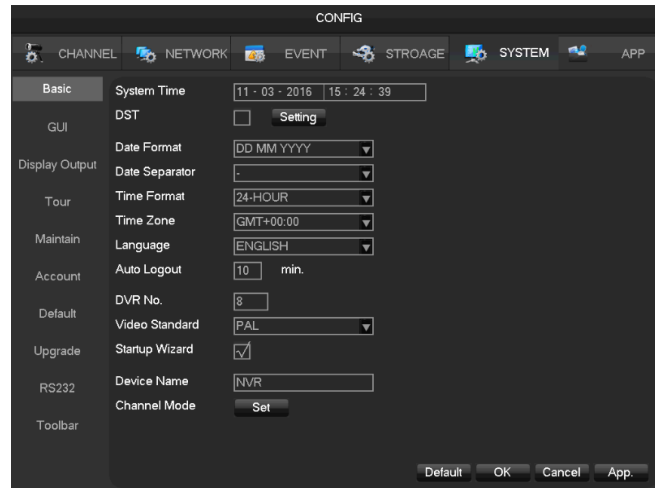

**[System Time]** set the HD record system time.



*Note: please click the "save" button to save the time after setting.*

**[Daylight Saving Time (DST)]** Enable the function and click "Set" to enter the local DST starting and ending time setting.

**[Date Format]** Modify the date display format.

**[Date Separator]** Select the separator for date.

**[Time Format]** 24 hour or 12 hour display mode.

**[Time Zone]** Select the time zone.

**[Language]** Select language (different models have different language choice).

### GUI Display

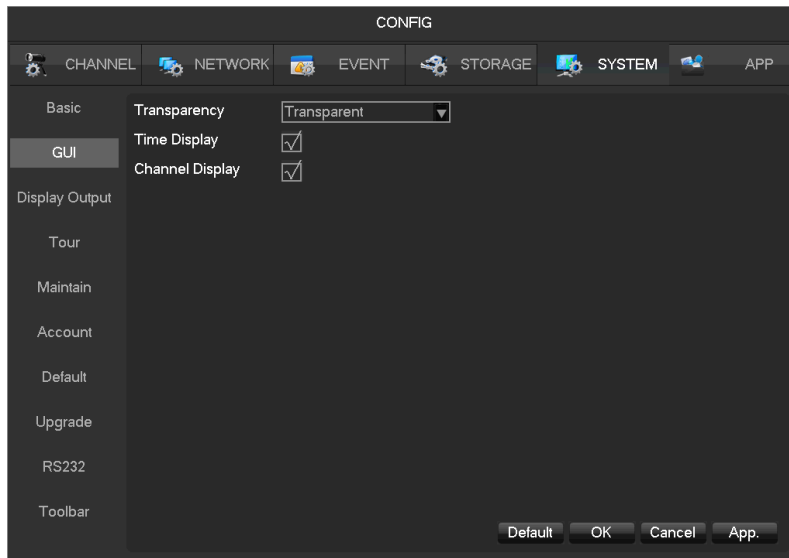

**[Menu Transparency]** Adjust menu transparency , four degrees

**[Time Display]** Enable switch for time displayed in live view

**[Channel Display]** Enable switch for channel name displayed in live view

## Display Output

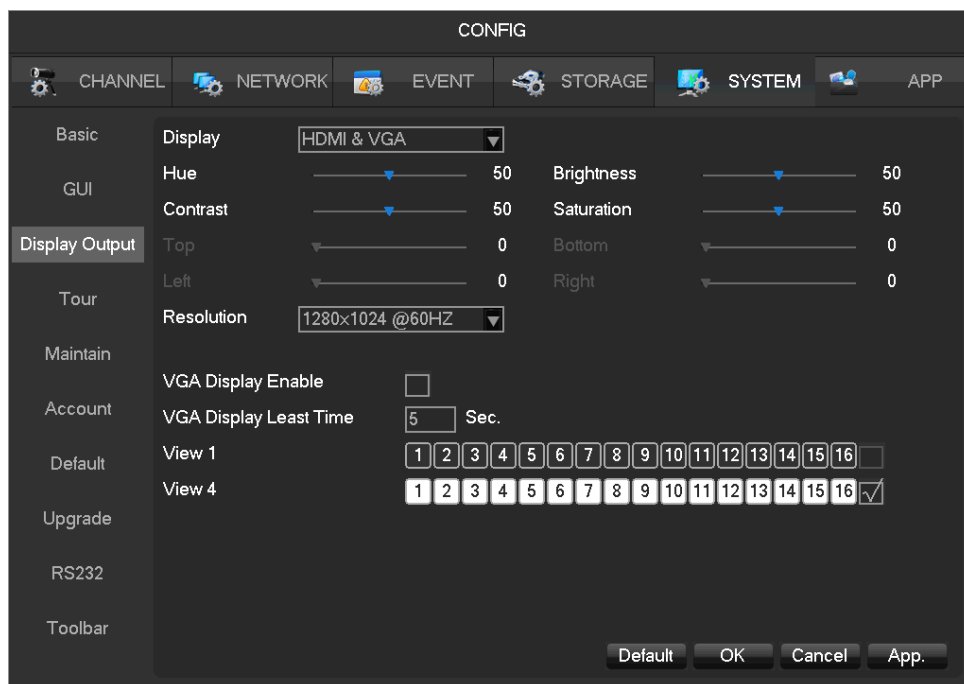

**[Display]** CVBS/HDMI&VGA

Under CVBS mode, user can adjust the monitor or TV hue, brightness, contrast and saturation. You can also adjust the right TV output area when the displayed image is not full or beyond the scope of the monitor. Under HDMI&VGA mode, user can only adjust the monitor hue, brightness, contrast

and saturation.

**[Resolution]** Select the VGA output resolution and refresh rate.

**[VGA Display Enable]** Enable it, then VGA and HDMI will display different image.

**[VGA Display Least Time]** Tour interval time, the value range is 5-120sec. The alarm information linkage to VGA auxiliary output need to enable single-screen or four-screen display.



*[VGA Display Enable] feature only for special models, the device you have may not support, please prevail in kind.*

## Tour

| Category       | Setting     | Value                    |
|----------------|-------------|--------------------------|
| Basic          | Enable Tour | <input type="checkbox"/> |
|                | Interval    | 5 Sec.                   |
| GUI            | View 1      | 1 2 3 4 5 6 7 8          |
| Display Output | View 4      | 1 2 3 4                  |
|                | View 9      | 1 2                      |
|                | View 16     | 1                        |
|                | Motion Tour | View 1                   |
|                | Alarm Tour  | View 1                   |

**[Enable Tour]** Enable switch.

**[Interval]** Tour interval time is 5-120s.

**[View]** It includes single screen, four-, nine-, sixteen-screen.

**[Motion Tour]** Set the motion detection tour mode.

**[Alarm Tour]** Set the alarm tour mode.

## Maintain



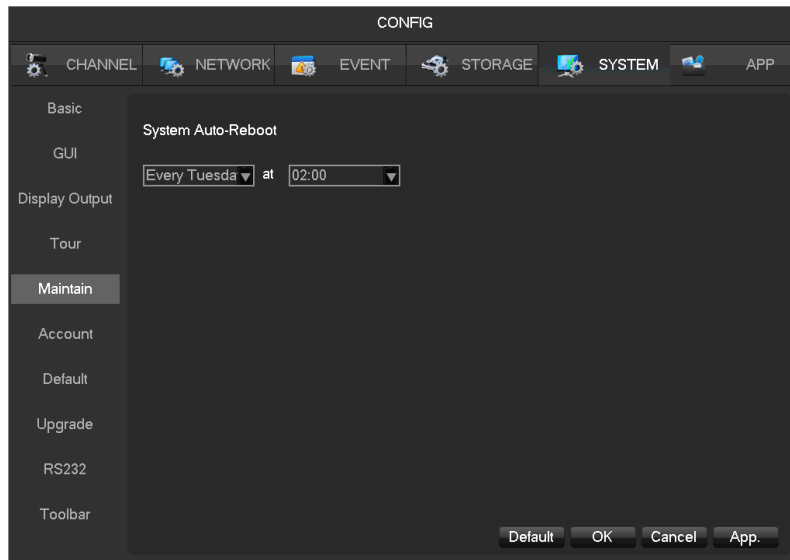

**[Auto maintain]** Set the desired the project of automatic maintenance.

## Account

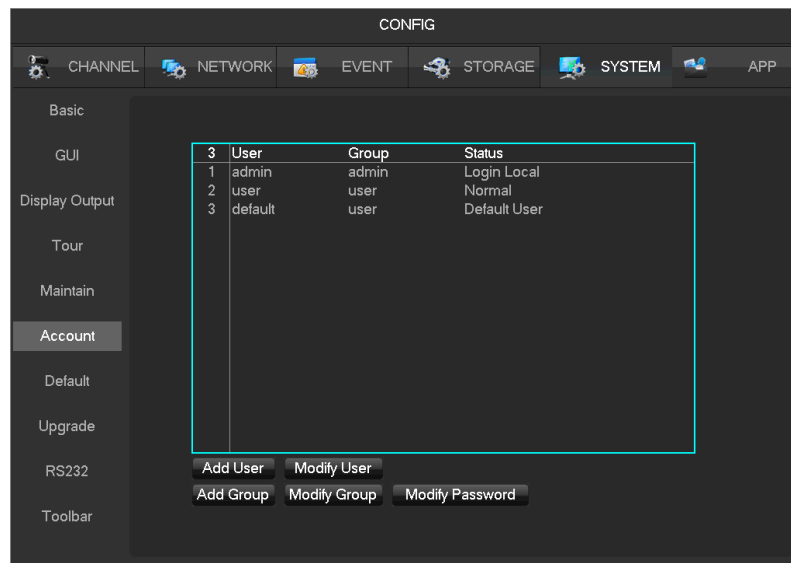

**[Add User]** Increase users within the group and settings user access control.

**[Modify User]** Modify the user and settings user access control.

**[Add Group]** Add group and settings group access control. Enter into the menu interface of Increase the group, determine the group name, select 83 access control, left click mouse button to confirm, save the new user group.

**[Modify Group]** To modify the group attribute which already exists.

**[Modify Password]** To modify password.

Select the user, enter old password then enter new password and confirm

Click **[confirm]** button to make sure modify password.

The password can be set 1-6. Beginning and ending spaces is invalid password, you can have a space in the middle.

Users which has User Account Control permission can change their own passwords, can also modify other users' passwords.



- *The following user names and user group names, etc., character and length consisting up to six bytes, the invalid string is trailing spaces. Legal characters: letters, numbers, underscores, minus sign, point, other characters are not allowed to use.*
- *the number of users and groups is not limited, User Group increased or delete according to user-defined: The factory settings are user \ admin two groups. Users can set their own related group, the group of users can be freely re-assign permissions at the group permissions.*
- *user management using two methods of user and group, Group name and the user name cannot be repeated, each user must belong to a group, a user can belong to only one group.*
- *There are three users: admin, user, and hidden default initialization. The factory password for first two are 123456. Admin default user permissions are high at the factory, and the factory default user as a low privileged user, only for monitoring, playback.*
- *Hidden default: This user system for internal use and cannot be deleted. When local is in "no user is logged" state, the system will automatically log in with this account. Users can modify this account permission to do what free login can do.*
  - *Enter to the menu interface of increase user, Enter your user name and password, select belongs to which group, and select whether to reuse this user. Reuse means that the account can be used simultaneously, multiple clients can use the account. .*

*Once the group belongs selected, the user's permissions only a subset of the group, not ultra vires the properties of the group.*

## **Default**

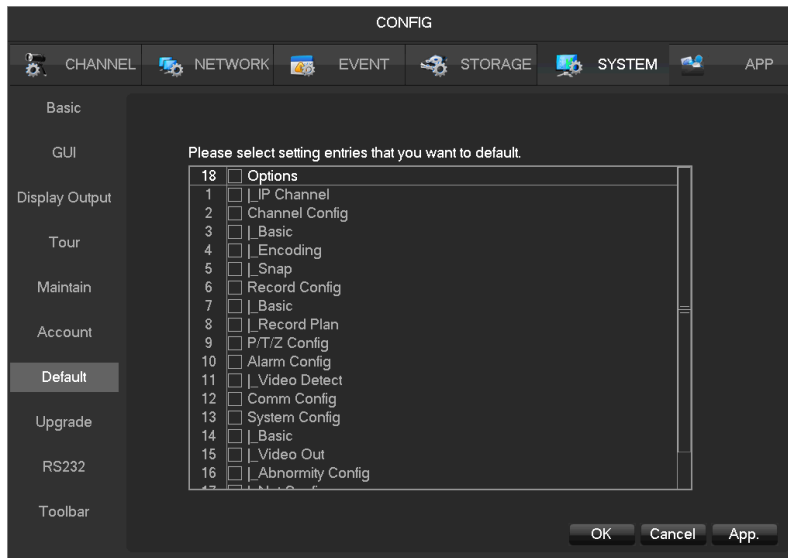

System back to the default configuration factory state (specific items recovered optional)



*IP address, mask, gateway, ports, user accounts, language, video standard will not be restored.*

## Upgrade

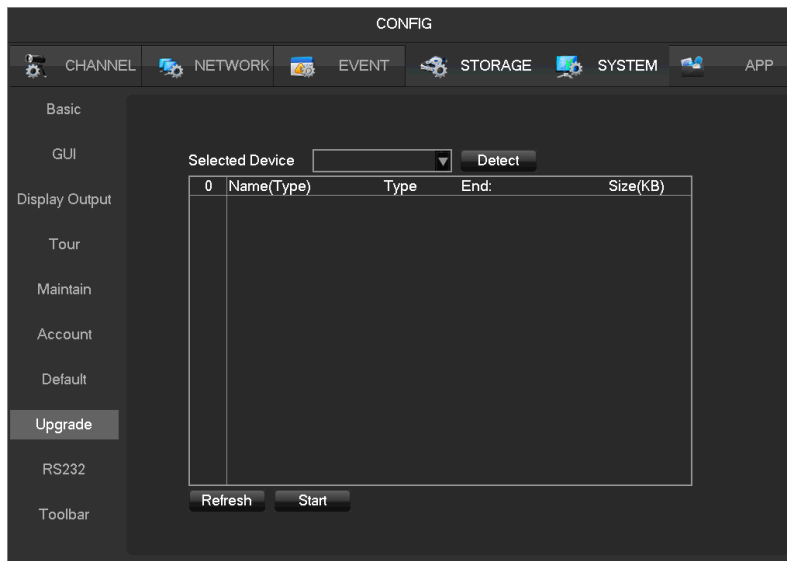

System software can be upgraded: Insert a USB storage device, click Upgrade.



*System upgrade may cause the DVR can not start properly, please Operation under the guidance of the company's technical staff.*

## RS232



**[Function]** Select the appropriate serial protocol.

**[Regular]** Used to update firmware and adjust.

**[Keyboard]** Used specialized keyboard to control the device by serial port.

**[Transparent serial port]** Used to transmit serial port data transparently.

**[Net keyboard]** Use specialized keyboard to control the device through network.

**[PTZ]** Connect with matrix.



*Note: some models do not have RS-232 serial port, please refer to some relative data sheet.*

**[Baudrate]** Select the relative length of baud rate.

**[Data Bits]** Default: 8.

**[Stop Bits]** Default: 1.

**[Parity]** Default: None.

## 7.3.6 APP Center

### DDNS

Dynamic DNS is a kind of system which point internet domain name to variable IP. According to the rule of internet domain name, domain name must associate with the fixed IP address. Dynamic DNS provide a fixed Name server for the dynamic domain, and then guide the domain search to the IP address of dynamic user through Name server, which can make the outside user connect to the dynamic user's URL.

#### 1、FNT DDNS

FNT DDNS is built-in professional dynamic DNS service in our network DVR. You can register directly in the device .Specific steps are as following.

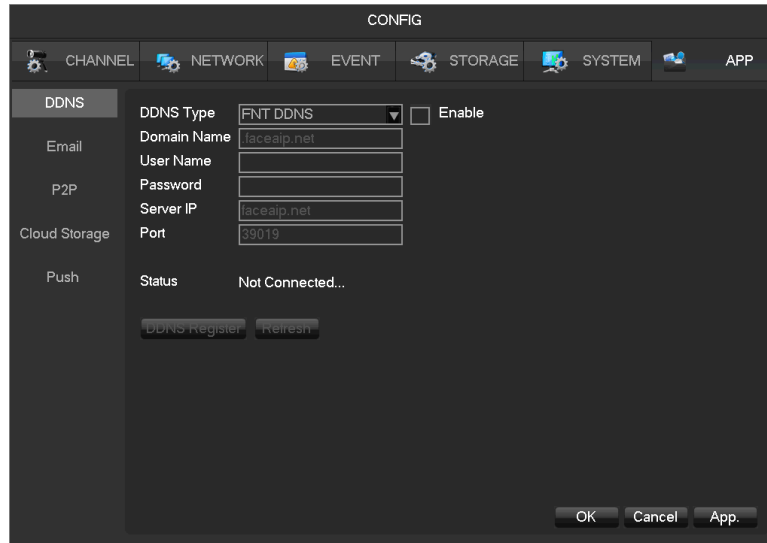

[Main menu]-[APP]-[DDNS], choose **FNT DDNS**.

- 1: Select FNT DDNS and Enabled it.
- 2: Input one user name, there will be a domain name generated auto. Domain name = user name.faceaip.net.
- 3: Input the password
- 4: Click “Register” button. If the domain name is not registered, it will pop up a message that connect DDNS server successfully otherwise it will prompt that the registration is failed.



*Suggestion: you'd best change the DNS server in basic configuration to the router's DNS server*

- 5: Click the “ok” button to complete the settings.

## 2、No-IP DDNS

Register new account at [www.no-ip.com](http://www.no-ip.com).

### Embedded DVR/NVR Setting:

Open [Main Menu]-[APP Centre]-[DDNS], choose NO-IP DDNS.

Refer to the following configuration:

| Name        | Configuration                          |
|-------------|--|
| DDNS type   | NO-IP DDNS                             |
| Host IP     | dynupdate.no-ip.com                    |
| port        | 80                                     |
| Domain name | xxx.xxx.org (xxx: domain name created) |
| User name   | xxx (user name registered)             |

|          |                              |
|----------|------------------------------|
| password | xxxxxx (password registered) |
|----------|------------------------------|

### 3、Dyndns DDNS

Register new account at [www.dyndns.com](http://www.dyndns.com).

#### Embedded DVR/NVR Setting:

Open [Main Menu]-[APP Centre]-[DDNS], choose NO-IP DDNS.

Refer to the following configuration:

| Name        | Configuration                          |
|-------------|--|
| DDNS type   | Dyndns DDNS                            |
| Host IP     | Members.dyndns.org                     |
| port        | 80                                     |
| Domain name | xxx.xxx.com (xxx: domain name created) |
| User name   | xxx (user name registered)             |
| password    | xxxxxx (password registered)           |

### Email

The screenshot shows the 'CONFIG' menu with the 'APP' tab selected. The 'Email' configuration page is active, displaying the following settings:

- SMTP Server:** MailServer
- Port:** 25
- User Name:** [Empty field]
- Password:** [Empty field]
- From:** [Empty field]
- Title:** DVR ALERT
- Receiver:** [Empty field]
- Receiver:** [Empty field]
- Receiver:** [Empty field]
- Event Interval:** 0
- Sec. SSL Enable:** [Unchecked]
- Enable:** [Unchecked]

Buttons: Test, OK, Cancel, App.

Refer to 9.1.8 Send Email.

### P2P

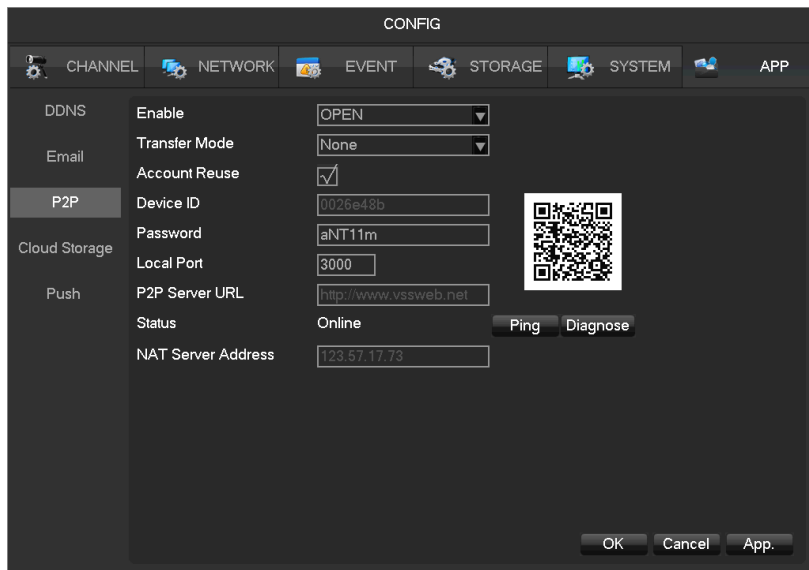

**[Enable]** Open/Close P2P function.

**[Transfer Mode]** Network transfer strategy, choose Quality priority or Fluency priority.

**[Account Reuse]** Enable it supports multiple users log in the same device.

**[Device ID]** Display device ID.

**[Password]** Device password.

**[Local Port]** Set local port.

**[P2P Server URL]** P2P server URL.

**[State]** Current connection state.

## Cloud Storage

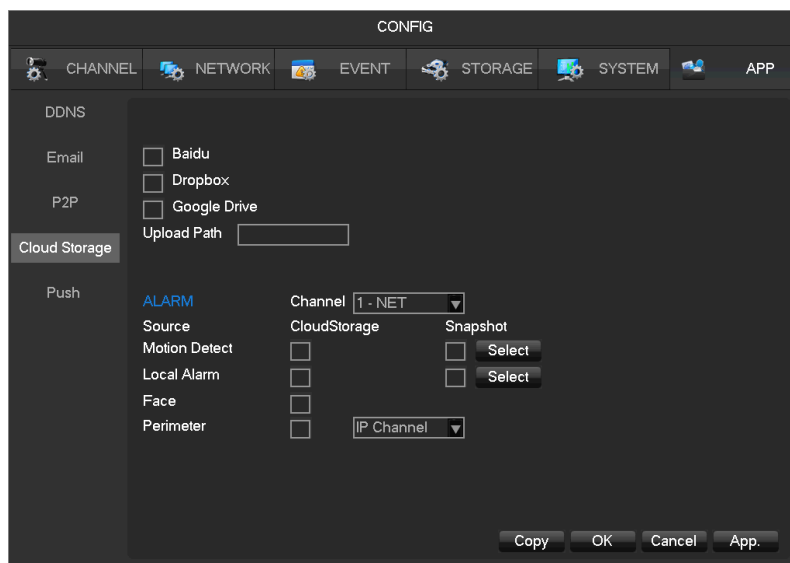

Refer to 9.1.10 Send Cloud NetDisk.

## Push

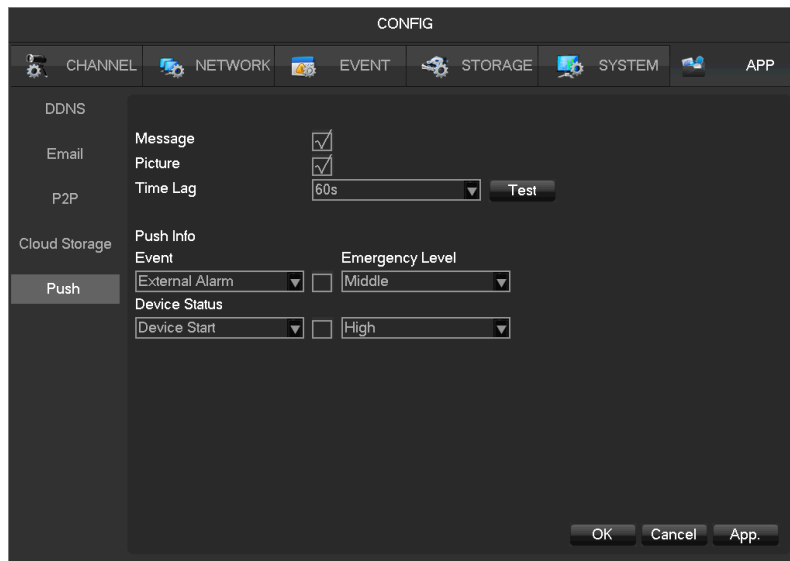

Refer to 9.1.9 Push Server.

# 8 WEB Access

## 8.1 WEB Operation

### 8.1.1 Network Connection

Check whether the DVR is on the network by checking B-Lamp on front panel, light indicates connection, otherwise connection error.

Set IP, subnet mask and gateway for computer and DVR. Please assign the same segment IP address without router, need to set the appropriate subnet mask and gateway with router.

The detail of DVR network configuration please see **[Configuration]-[Network Setting]**.

Ensure the IP is correct and check whether the DVR is on the network by using the Windows command “ping”.



## 8.1.2 The control installation and the user login logout

Users can remote access to DVR by Internet Explorer, assuming you have a correct network configuration.

The following interface will pop up when you access the IP address in Internet Explorer.

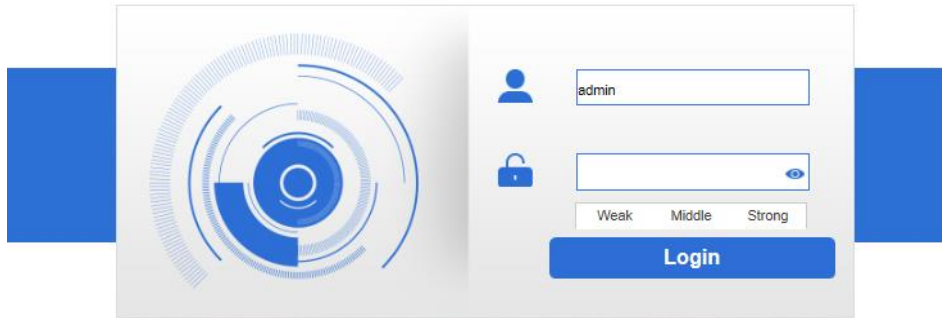

The following interface will pop up when you log in.

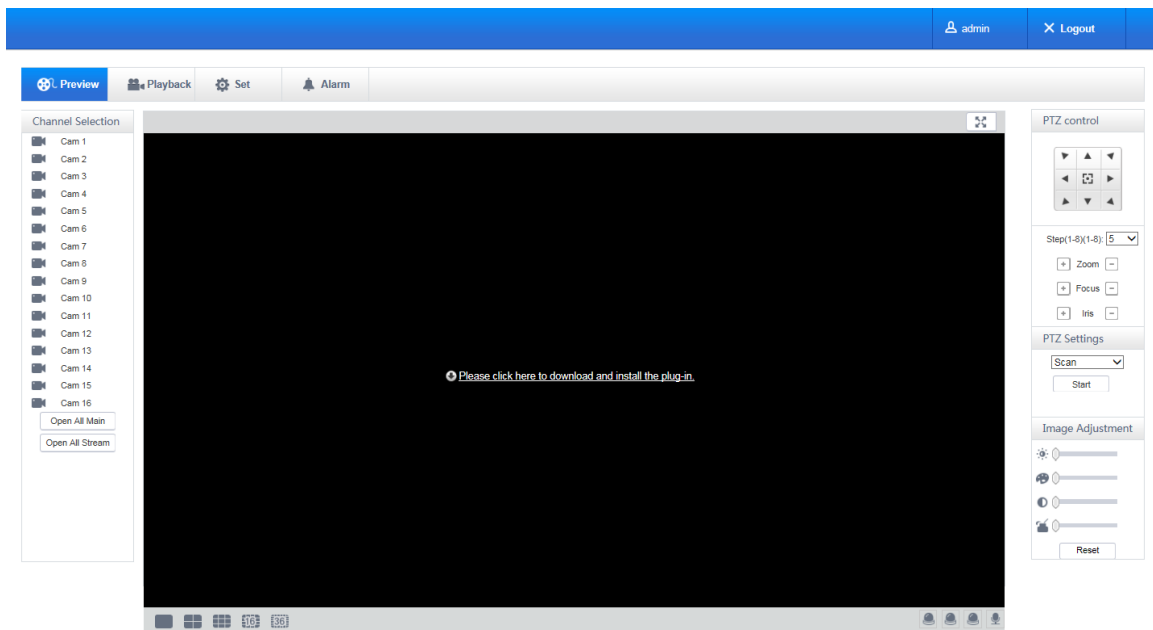

Will be displayed in Compatibility View option is checked on all websites.

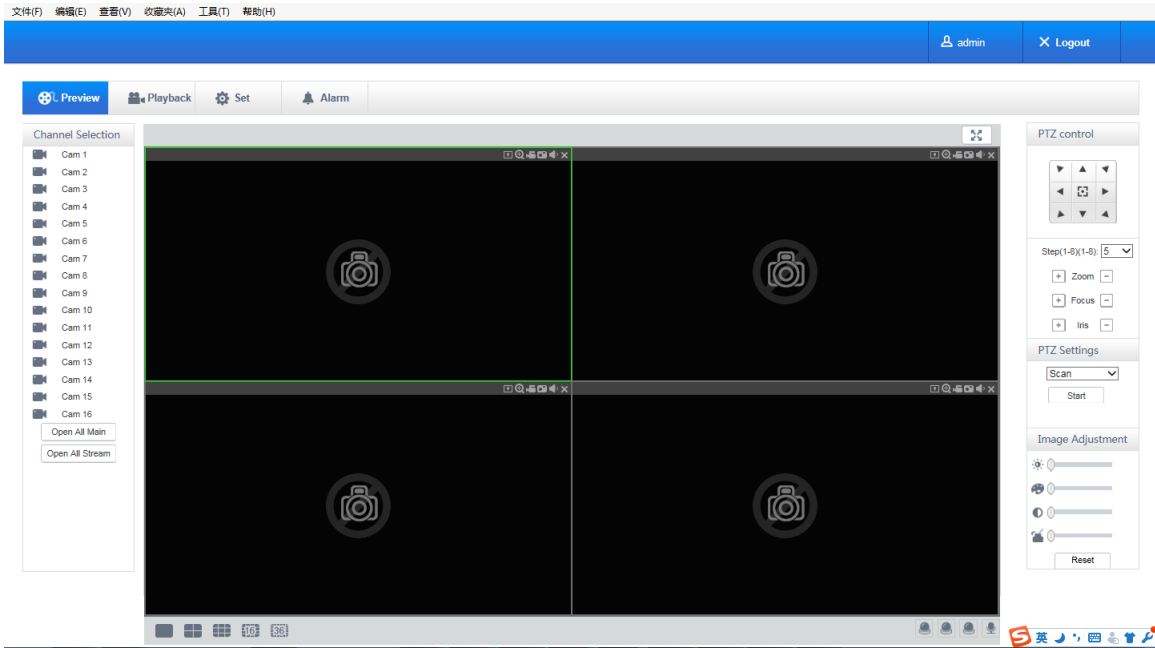

### 8.1.3 The Interface of Web Operations

#### WEB Interface Description

After log in the web, the preview interface will pop as following:

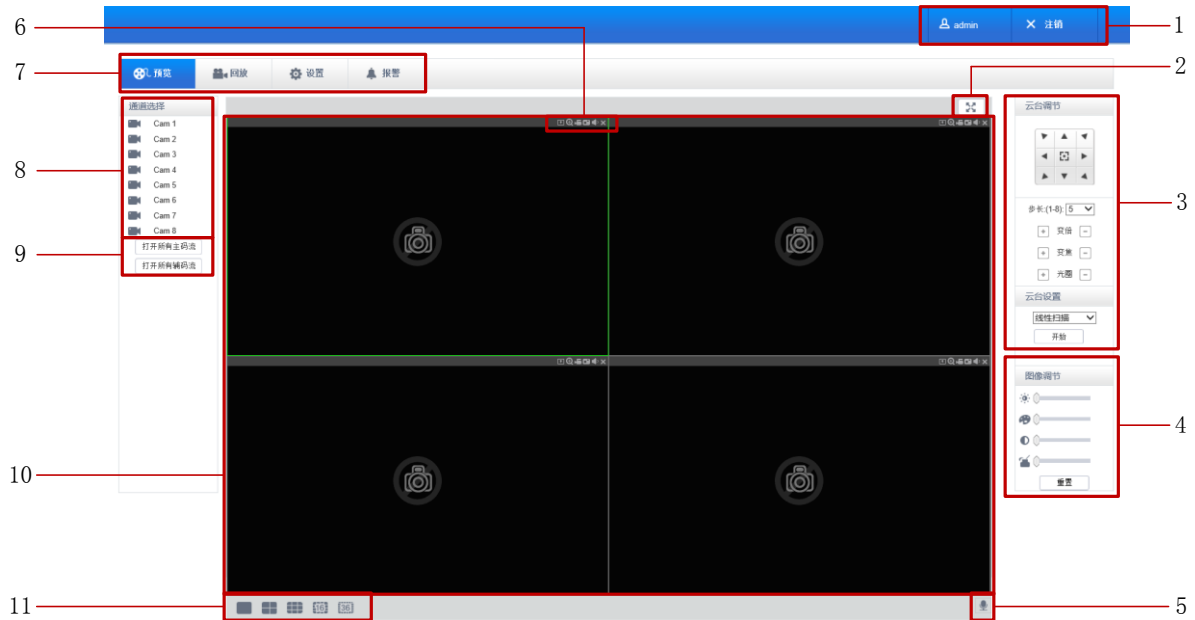

WEB Interface Description

| Index | Name        | Description                                   |
|-------|-------------|---|
| 1     | Log out     | Show the current login user, click on log out |
| 2     | Full screen | Full screen preview                           |
| 3     | PTZ control | PTZ control menu                              |

|    |                                |   |
|----|--------------------------------|---|
| 4  | Image color & other saturation | Image color: modify brightness, contrast and<br>Other: set capture path, record download path and reboot      |
| 5  | Device function key            | Two way talk function key and etc.  |
| 6  | Channel function key           | screenshots, electronic amplification function keys and etc   |
| 7  | Menu                           | System configuration, record search, alarm setting, exit, etc.  |
| 8  | Channel Selection              | Realtime channel preview selection  |
| 9  | All open key                   | Open all can be open all channels real-time monitoring (main/auxiliary stream) in the video monitoring window |
| 10 | Surveillance window            | Real time recording or playback   |
| 11 | Channel segmentation window    | Provide the single picture, 9, 4 picture image segmentation method.   |

### Select the focus window

Into the WEB interface, select the focus window in live window, the focus window has a light green border.

### Preview Channel Selection

The left channel column is as following picture:

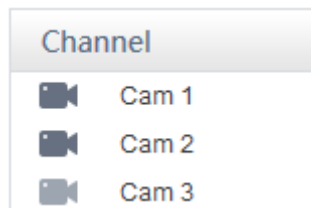

Left-click on any channel, the focal channel open with the main stream, and channel focus automatically moves to the next channel.

After opening the live video, the left channel column is as following picture:

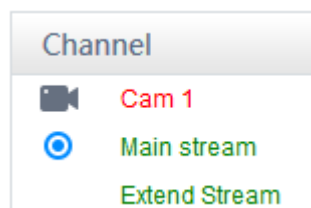

### The Real-time Monitoring









Preview window's Lower left corner shows the current video channel name.

Preview window's Upper right corner shows the current video time information.

Upper left corner shows the current DVR's IP, resolution, bit rate.

Upper right corner shows the function keys.

-  Smart Information: Show the intelligent analysis information.
-  Local Range: Video images can be enlarged.
-  Local Record: Save and record video to a local HDD while in a live view. Set recording path in configuration.
-  Capture: capture of the present channel, set the path in "other."
-  Audio: on/off sound.
-  Close video: off the focus window video.

### **Screen split**

Click “” (Lower left corner of the display window) to switch between single screen and multi-screen.

### **PTZ Control**

Set protocol ( see **[Setting]-[PTZ]** )

Control PTZ direction, step size, zoom, IRIS, preset, tour, pattern, border scan, light, wiper, auto pan, etc.

Step size controls PTZ direction and speed, e.g. step size 8 is moved faster than step size 1.

Eight direction rotations: up, down, right, left, up-left, up-right, lower left, lower right.

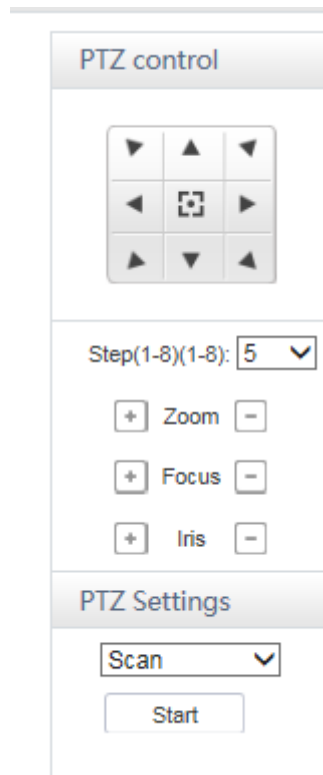

### **Border scan**

Operation: select the camera line scan of the left/right margin by direction button, and click the Settings button in the left /right margin position to determine the left border.

### **Preset**

Operation: modify preset position by direction button and inputting a preset number, then click “Add” to save.

### **Tour**

Operation: select “Tour”; Point between the first cruise line cruise input box value. And input numbers in “Path” and “preset”. Click[**Add Preset**]to add one preset in the cruise path, and repeat to add additional presets. Click [**Clear Preset**]to delete a preset, repeat to delete more.

### **Pattern**

Operation: Click “Pattern” in order to record an automated pattern. Then, go back to the PTZ controls in order to modify the zoom, focus and IRIS, etc. Stop recording in “Pattern” setting to save the pattern.

### **AUX**

On/off one of AUX.

## Wiper

On/off wiper under protocol.

### 8.1.4 Configuration

Access DVR local configuration menu by click “System Setting”, the further details please refer. **[Local operation guide]**

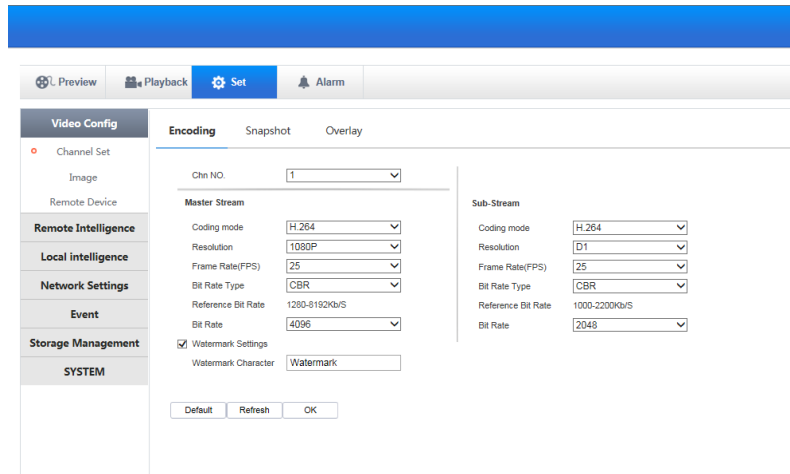

### 8.1.5 Search Record

Click **[Playback]** to open the search interface:

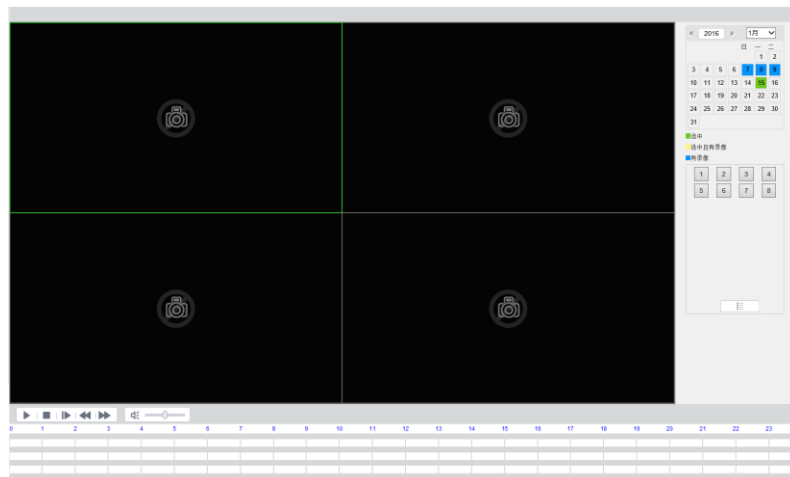

Up to playback 4 channels simultaneously.

### Search record

By selecting the record type, start and end times, and click the check button, get a list of files on the DVR.

Select the appropriate file and download can be played

## Play

Double click a search result to play in video window. Control the playing video by the control keys on the bottom. At this point, the bottom of the video window will display the video control buttons, video playback can be controlled.



## Download

Select a searched video to download to local. The download speed and percentage are displayed on the bottom of the screen.

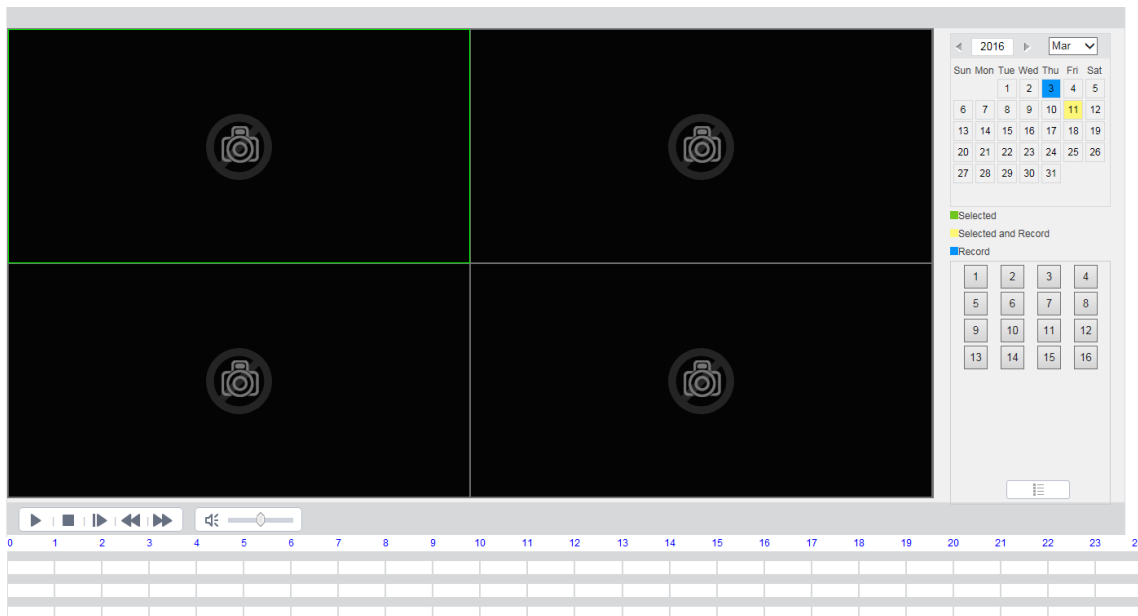

## 8.1.6 Alarm Configuration

Click the **[Alarm]** to enter the alarm setup menu:

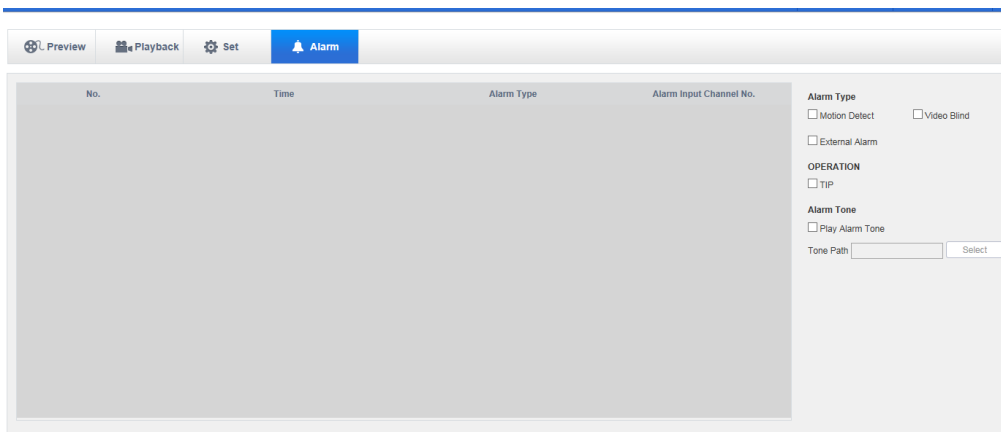

If need warning message displayed and real-time pop up on the WEB interface, open the **[monitor alarm]**, and select the appropriate type of alarm.

Choose type of alarm on menu, monitor video loss, motion detection, disk full, disk error, video mask, external alarm.

Click **[Video Pop-up]**, open the video loss, motion detection, hard disk full, hard disk failure, video block, video encoder alarm pop-up linkage.

Click **[prompt]**open the prompt: When an alarm occurs in real-time monitoring will popup alarm window menu.

Click **[Sound Pop-up]**, you can choose alarm tone pre-recorded on the local hard drive when an alarm occurs, tone file in WAV format.



# 9 Appendix

## 9.1 Alarm linkage setting

Alarm linkage settings interface as following.

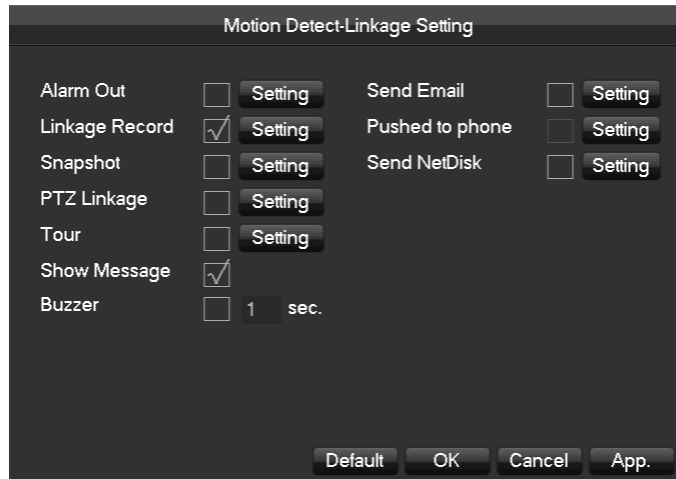

### 9.1.1 Alarm Out

Linkage the device alarm through the interface as following:



Support 10s-300s alarm-delay.

### 9.1.2 Linkage Record

Video channel linkage.

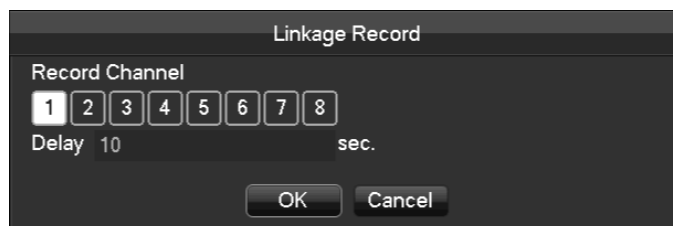

Support 10s-300s alarm-delay.

### 9.1.3 Snapshot

Screenshots through channel linkage as the interface following:

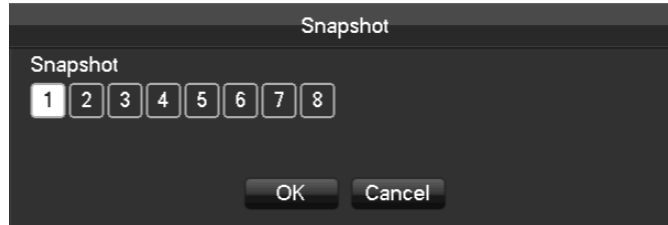

Configure the screenshots by setting [main menu]-[screenshot setting].



*If the access channel is the network channel, please check if the screenshot function is open of the camera.*

### 9.1.4 PTZ Linkage

Preset position, cruise, trace by setting the PTZ linkage.

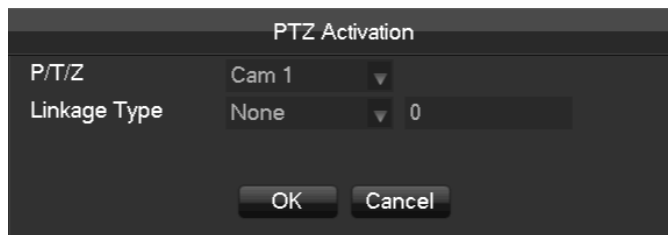

Preset position, cruise, trace by setting the PTZ configuration. See details on page 6.6.2.

### 9.1.5 Tour

Select the round tour channel when the alarm occurs, select the single channel to the round tour.

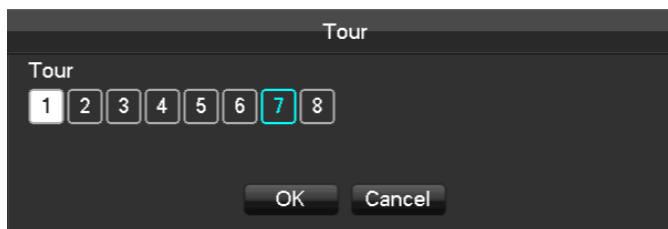

### 9.1.6 Show Message

Select the prompt to open the screen, if it occurs alarm, the preview screen will pop up the prompt as following:

| Alarm Status |                          |                          |   |   |   |   |   |   |   |    |    |    |    |    |    |    |
|--------------|--------------------------|--------------------------|---|---|---|---|---|---|---|----|----|----|----|----|----|----|
| Alarm In     | 1                        | 2                        | 3 | 4 | 5 | 6 | 7 | 8 | 9 | 10 | 11 | 12 | 13 | 14 | 15 | 16 |
| Video Lost   | 1                        | 2                        | 3 | 4 | 5 | 6 | 7 | 8 |   |    |    |    |    |    |    |    |
| Mask         | 1                        | 2                        | 3 | 4 | 5 | 6 | 7 | 8 |   |    |    |    |    |    |    |    |
| Motion       | 1                        | 2                        | 3 | 4 | 5 | 6 | 7 | 8 |   |    |    |    |    |    |    |    |
| Network      | <input type="checkbox"/> | <input type="checkbox"/> |   |   |   |   |   |   |   |    |    |    |    |    |    |    |
| IP Conflict  | <input type="checkbox"/> | <input type="checkbox"/> |   |   |   |   |   |   |   |    |    |    |    |    |    |    |

### 9.1.7 Buzzer

Select the buzzer, the buzzer can last 1s-600s.

### 9.1.8 Send Email

Email configuration interface is as following:

| CONFIG        |                |                          |                          |        |     |
|---------------|----------------|--------------------------|--------------------------|--------|-----|
| CHANNEL       | NETWORK        | EVENT                    | STORAGE                  | SYSTEM | APP |
| DDNS          | SMTP Server    | MailServer               | <input type="checkbox"/> | Enable |     |
| Email         | Port           | 25                       |                          |        |     |
|               | Anonymous      | <input type="checkbox"/> |                          |        |     |
| P2P           | User Name      |                          |                          |        |     |
|               | Password       |                          |                          |        |     |
| Cloud Storage | From           |                          |                          |        |     |
|               | Encryption     | None                     |                          |        |     |
| Push          | Title          | DVR ALERT                |                          |        |     |
|               | Receiver       |                          |                          |        |     |
|               | Receiver       |                          |                          |        |     |
|               | Receiver       |                          |                          |        |     |
|               | Event Interval | 0                        |                          | Sec.   |     |
|               | Test           |                          |                          |        |     |
|               | OK Cancel App. |                          |                          |        |     |

Configure the SMTP server, IP address, ports, user name, password and the email address of the sender, SSL/TLS encrypt the email, and support sending anonymous messages. The title of the email can support English and the Arab number, the maximum input characters reach as much as 32 characters.

## 9.1.9 Server Push

Server push configuration interface as following:

**[Send Message]** Open or close the mobile phone message sending.

**[Image Attachment]** Open the function of image attachment.

**[Time Lag]** Set the time lag of the message sending, 60s/90s/120s is optional.

**[Test]** Click Send to test the message sending function

**[Event]** Open or close the event sending, the events including external alarm, face detection, perimeter intrusion detection, VQD, motion detection.

**[Device exception]** Open and close the device exceptional sending, the exception including the device startup, no hard dick, error hard dick, start recording/stop recording.

**[Urgency Degree]** The message sending level can be divided into High/Medium/Low level.

## 9.1.10 Send NetDisk

Choose Baidu cloud disk, Dropbox, Google one, according to clew for binding.

Support motion detection, video occlusions, local alarm ( face/perimeter ) alarm and other alarm types.

Can linkage other channels to upload the captured pictures



## 9.2 Port Mapping

Port mapping is mapping a port of outside web host's IP address to a machine inside web, and provide the service. When user connects to the port of the IP, the server will automatically map the request to the corresponding machine inside LAN. With this function, we can map many ports of a machine's IP address to different machines' different ports inside web.

The port mapping can also have other special agent functions, like POP, SMTP, Telnet and so on. Theoretically, it can provide more than sixty thousand ports. For example, if we want to map a web server which has an IP address of 192.168.111.10, we just need to input the IP address and TCP port 80 into the port mapping chart of the router.

There are two ways to map the port: UPnP function automatically map and modify the router's port mapping chart by manual.

### 9.2.1 UPNP Function

In order to get connection to the Embedded DVR through Public network, we need to set the Router to cross the NAT of Embedded DVR. UPnP can make the NAT cross automatically by the UPnP agreement of Embedded DVR, and don't have to set the Router.



*To realize the UPnP Function, there must be Router support and enable the UPnP Function.*

#### **The first step**

Connect the Router to the network, get to the Menu of the Router, set the Router, and enable the UPnP

Function.

Routers made by different manufacturers may have some difference, please refer to the specification carefully before setting the Router.

#### **The second step**

Connect the Embedded DVR to the Router; the configuration will automatically gain the IP address or static IP. After setting up the IP, click the Advanced. And get to the XXX, ports and multicast etc. choose to open the Enable at the [UPnP port mapping]

#### **The third step**

Enter into the Router management interface; detect the port if there is already a Port mapping. If there is, it shows UPnP setting's finished.

#### **The fourth step**

Input the IP address in IE, and add port number of the Embedded DVR, for example: 155.157.12.227:81. If you want to enter by the Client Software, use the TCP port offered by the outer net.



*If there are a few embedded DVRs need to set the UPnP function, in order to avoid IP conflict, set the ports of embedded DVR into different ports numbers. Otherwise, it will choose the embedded DVR port set preceded as the first choice.*

## **9.2.2 Port mapping Manually**

#### **The first step**

Connect the Embedded DVR to the Router, set the static IP.

#### **The second step**

Log in Router, enter into the configuration menu of Router, and set the menu. Then get to port, set the IP distributed by the Embedded DVR, and set the rule of port mapping, add HTTP and TCP port into mapping list.

Default access ports of Embedded DVR include HTTP port 80 and TCP port 8000, if the ports are occupied by the other device, please modify the default port of the Embedded DVR into other vacant ports.

#### **The third step**

Input the public net IP address in the IE, and add the port number of the Embedded DVR you want to access after the IP, for example: http://155.157.12.227:81. If you want to access by Client Software, you can use the outer net TCP port directly.



*For detail configuration setting, please refer to the user manual of Router.*

## 9.3 Voice Intercom

### 9.3.1 Summarize

Embedded DVR Bidirectional Talk: user can talk to remote client software or Web via DVR audio input and output ports; user can listen voice from Client Software and WEB via DVR audio output ports.

Two types of bidirectional talk ---- sharing and standalone ----for different models, exact info please refer to specifications.

### 9.3.2 Configuration

#### **Local configuration**

Connect a microphone to the MIC input port, connect loudspeaker to the audio output port.

If no standalone MIC input port, please connect microphone to the number 1 audio input port



*Local output needs active audio output device.*

#### **Remote PC Configuration**

Connect microphone and loudspeaker to computer.

Enable bidirectional talk in IMS software or WEB.

## 9.4 HDD S.M.A.R.T

### **S.M.A.R.T: “Self-Monitoring, Analysis and Reporting Technology”**

S.M.A.R.T HDD can analysis head, disc, motor, circuit operation, history and default security values via monitor instruction in HDD and surveillance software in host. Alarm will be sent to user automatically when the value is outside the scope of the security situation.

Detection parameters of Seagate HDD for example are divided into seven: ID detection code, Attribute Description, Threshold, Attribute Value, Worst, Date, and Status.

## 1、 ID detection code

ID detection code is not the only; manufacturer can use different ID code or increase or decrease its quantity according to the detected parameter's quantity.

For example: the ID detection code of WEASTERN DIGITAL's product is "04", parameter is Start/Stop Count, but the parameter of same code in Fujitsu's product is "Number of times the spindle motor is activated".

## 2、 Attribute Description

Attribute Description: name of detection item. Manufacturer can increase or decrease. As ATA standard update constantly, sometimes different models in same brand maybe different ,but must ensure major test items specified in S.M.A.R.T .(although different manufacturers have specific naming convention ,the essence of monitoring is the same.)

1 Read Error Rate

2 Spin up Time

4 Start/Stop Count

5 Relocated Sector Count

7 Seek Error Rate

9 Power-on Hours Count

10 Spin up Retry Count

194 Power temperatures

195 ECC on the Fly count

197 Current Pending Sector Count

198 Disconnection beyond repair

199 CRC cyclic redundancy check

200 Write Error Count



*Different manufacturers and different models have different attribute description , the user has no need to know exact meaning ,attribute detection values enough for them.*

## 3、 Threshold

It is specified by manufacturer calculated through a specific formula. If there is a attribute value lower than the threshold, which means HDD become unreliable and data stored is very easy to lose. Composition



and size of reliable attribute values is different for different HDD. It should be noted that, ATA standard only provides some SMART parameters; it does not provide a specific value. "Threshold" value is determined by manufacturers based on products' features. Thus, results tested by manufacturer provided detection software is very different from testing software under Windows (such as AIDA32)

#### **4、 Attribute Value**

Attribute value is the maximum normal value; the general range is from 1 to 253. Typically, the maximum attribute value is 100 (for IBM, Quantum, and Fujitsu) or 253 (for Samsung). Of course, there are some exceptions, for example, some models produced by Western Digital have two different attribute values, and property value is set 200 when initial production, but after then it is changed into 100.

#### **5、 Worst**

Worst value is the largest non-normal value in HDD's running. It is a value calculate for HDD's cumulative running, it is constantly refreshed according to running cycle, and very closed to the threshold. Whether the HDD is normal by S.M.A.R.T analysis is based on the comparison with threshold. The maximum value appear when new HDD start to use, which would continue to decrease with the everyday use or error happen. Consequently, larger attribute values mean better quality and higher reliability; smaller values mean more possibility of failure increases.

#### **6 、 Dates**

Actual values of HDD's detection items, many items are cumulative values.

#### **7、 Status**

It is current statuses of HDD's every attribute after analyzing and comparing above attribute values by S.M.A.R.T, also is important information to judge HDD healthy or not.

There are three statuses: Normal, Alarm and Error----which is closely related with Pre-failure/advisory BIT.

## **9.5 Hard disk problem**

Use Detection Tool provided by the HDD manufacturer to detect the Function of HDD to solve data problem.

We recommend Seagate and Western Digital.

#### **How to detect Seagate HDD**

a) Get into [www.seagate.com](http://www.seagate.com), Click Support & Downloads →choose Sea Tools, download tool, as Diagram

## SeaTools for Windows

SeaTools for Windows tests SATA, USB, 1394, ATA (PATA/IDE) and SCSI drives. It installs onto your system. SeaTools for Windows is completely data safe. If the drive passes SeaTools for Windows, your troubleshooting can move to other areas.



b) Double-click `SeaToolsforWindowsSetup-1205.exe` to install downloaded file, click `SeaTools for Windows` installed file to detect the HDD information on PC.

c) Choose the HDD for detection (other manufacturer's hard disk suitable too).



## How to detect WDC HDD

a) Get into [www.wdc.com](http://www.wdc.com), choose WD support / download / SATA&SAS / WD Caviar / GP, download software as 错误!未找到引用源。

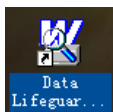

b) Click `Data Lifeguard...` to hard disk detection after downloading.

c) Double click hard desk in device list, as 错误!未找到引用源。 :

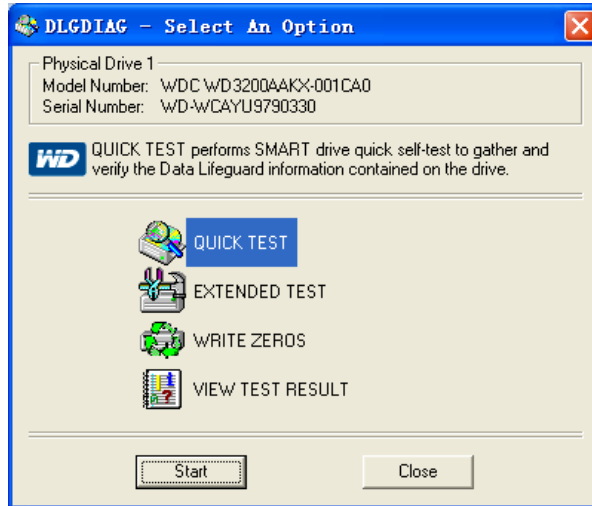

## 9.6 HDD Capacity Calculation

### Reference of HDD Capacity Calculation

The first time install DVR, please check if the HDD has installed.

### The capacity of the HDD

There is no limitation of capacity of single HDD to DVR, please choose the HDD according to the saving time.

### The choose of the Capacity

Computational formula of HDD Capacity:

Whole HDD Capacity = number of the channels × time in need (hour) × spent of HDD Capacity per hour (MB/hour)

Similarly we can have the formula of recording time:

$$\text{Recording time (hour)} = \frac{\text{Total HDD Capacity (MB)}}{\text{Capacity Occupation per Hour (MB/hr)} \times \text{Amount of Channel}}$$



1GB=1000MB, not 1GiB=1024MiB, so HDD capacity shown in Base Configuration under HDD Management less than real marked.

File size per hour (CBR).

| Bit Rate | File | Bit Rate | File | Bit Rate | File |
|----------|------|----------|------|----------|------|
| 96k      | 42M  | 320k     | 140M | 896k     | 393M |
| 128k     | 56M  | 384k     | 168M | 1.00M    | 450M |
| 160k     | 70M  | 448k     | 196M | 1.25M    | 562M |
| 192k     | 84M  | 512k     | 225M | 1.50M    | 675M |

|      |      |      |      |       |      |
|------|------|------|------|-------|------|
| 224k | 98M  | 640k | 281M | 1.75M | 787M |
| 256k | 112M | 768k | 337M | 2.00M | 900M |

File size is more unpredictable when VBR style, please refer to the real size of recording file.

## 9.7 Terms

### Dual-stream

Dual-stream: one high bit rate stream for the local HD store, QCIF/CIF/2CIF/DCIF/4CIF coding, other low bit rate stream for network transmission, such as QCIF / CIF coding,

### I Frame

I frame: intra frame image, remove redundant information to compress the transmittal data, also called key frames.

### B Frame

B frame: According to time redundant of the source image sequence previously encoded frame and account the source image after the encoded frame to compress transmittal data, also known as bi-directional prediction frame.

### P Frame

P-frame: according to image frame lower than the previous time redundant to compress transmittal data, also called predicted frames.

### Wide Dynamic

Bright parts and dark parts in particular can be seen very clearly at the same time. Wide dynamic range is a ratio between the brightest luminance signal value and the darkest value.

### S. M. A. R. T

SMART (Self Monitoring, Analysis and Reporting Technology): now widely used in hard disk data security technology, monitoring system analysis Motor, circuit, HDD and disk head when HDD working, warn when abnormality, sometimes will automatically slow down and back up data.

### CVBS

Composite Video Broadcast Signal, consists of luminance and color signal from the composite baseband signal.

### BNC

Coaxial cable connector, composite video signals or audio signals, commonly use 75 ohm connectors. BNC welding and should pay attention to weld strength and remove burrs, or the signal wire and shield's contact will lead to a substantial attenuation of signal strength

## 9.8FAQ

### **DVR startup failure or continuously reboot**

Possible reasons:

1. The system has been damaged from a bad DVR update.
2. There is a problem with the DVR main board error, please contact supplier.
3. There is an HDD error. Replace faulty HDD.

### **Remote control does not work**

Possible reasons:

1. Check for batteries in remote control, especially positive and Negative.
2. Check for batteries' power.
3. Check if remote receiver is obscured.
- 3 Check if DVR address corresponds to the remote address.

### **DVR cannot control PTZ**

Possible reasons:

1. RS-485 cable connection error, A, B ports are inversely connected;
2. PTZ decoder, protocol, baud rate, address are incorrect;
3. Parallel connect a 120Ω resistance to resolve signal reflex caused by too many PTZs on the line.
4. The RS-485 on the DVR is defective

### **Blurred screen in preview mode**

Possible reasons:

Please make sure your cameras match your video format selected in the General menu. E.g. camera is NTSC standard but the DVR is PAL standard, the preview would be blurred.

### **Blurred screen in playback mode or failure to playback records**

Possible reasons:

1. Procedure error, reboot the DVR
2. HDD error, test or change out the HDD
3. DVR hardware failure, contact your local supplier

### **Fail to connect DVR through network**

Possible reasons:

- 1、 check the physical network connection is correct.
- 2、 check the DVR network configuration parameters.
- 3、 check whether IP conflicts exist in network.

### **Download records can't be played**

Possible reasons:

- 1 、 Player installation error.
- 2 、 The USB or HDD device has an error.
- 3 、 Do not install graphic software later than DX8.1.

### **Internet Explore Crash**

Possible reasons:

Close IE explore, enter into the tool bar

